

GP028-0039,1

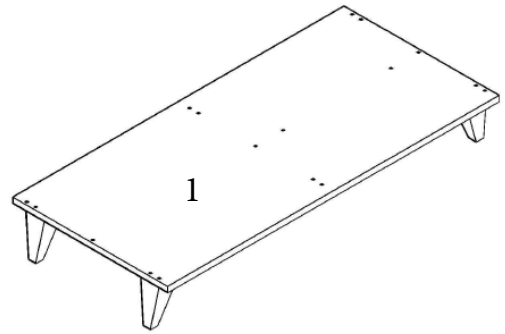

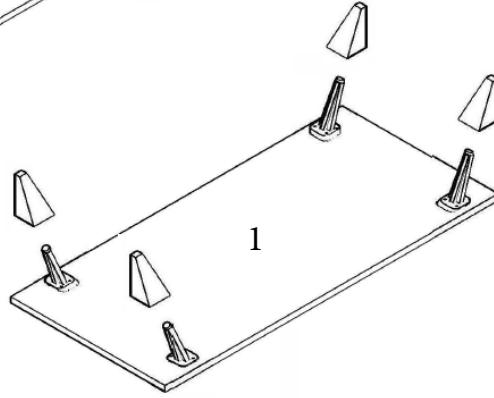

X 16

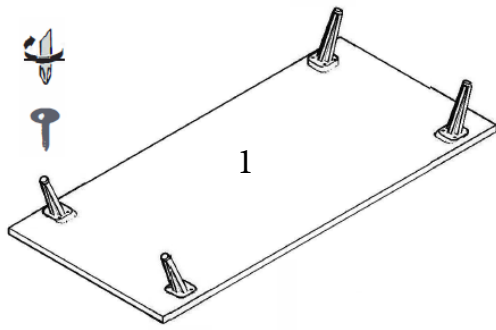