

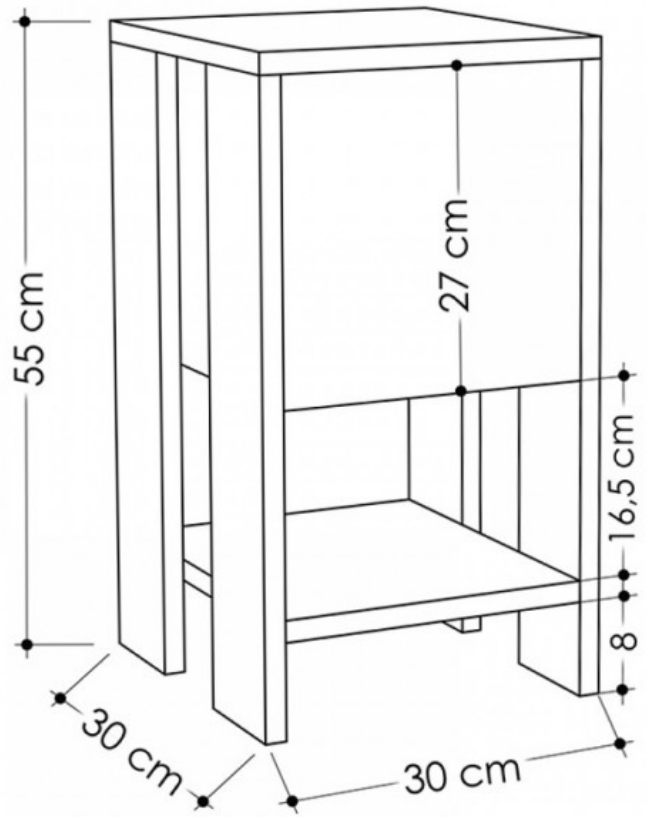







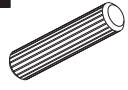
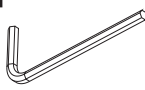
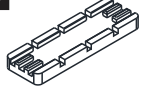

GP037-0010,2

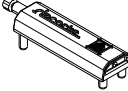

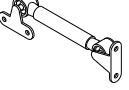
A22 Minifix k18  20x	A23 Minifix M10  20x	A04 Ø8  16x	A12 Allen  1x	A08 5mm  4x
B03 25 mm  4x	A69 P.D.  4x	A80 bas ac  1x	A82 bas ac k.  1x	Y03 Ctpb  4x
Z67 DKP  1x	A18 3,5x18  4x	A06 18mm  C1-20x	A65 Mil Mentese  2x	

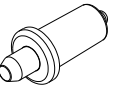
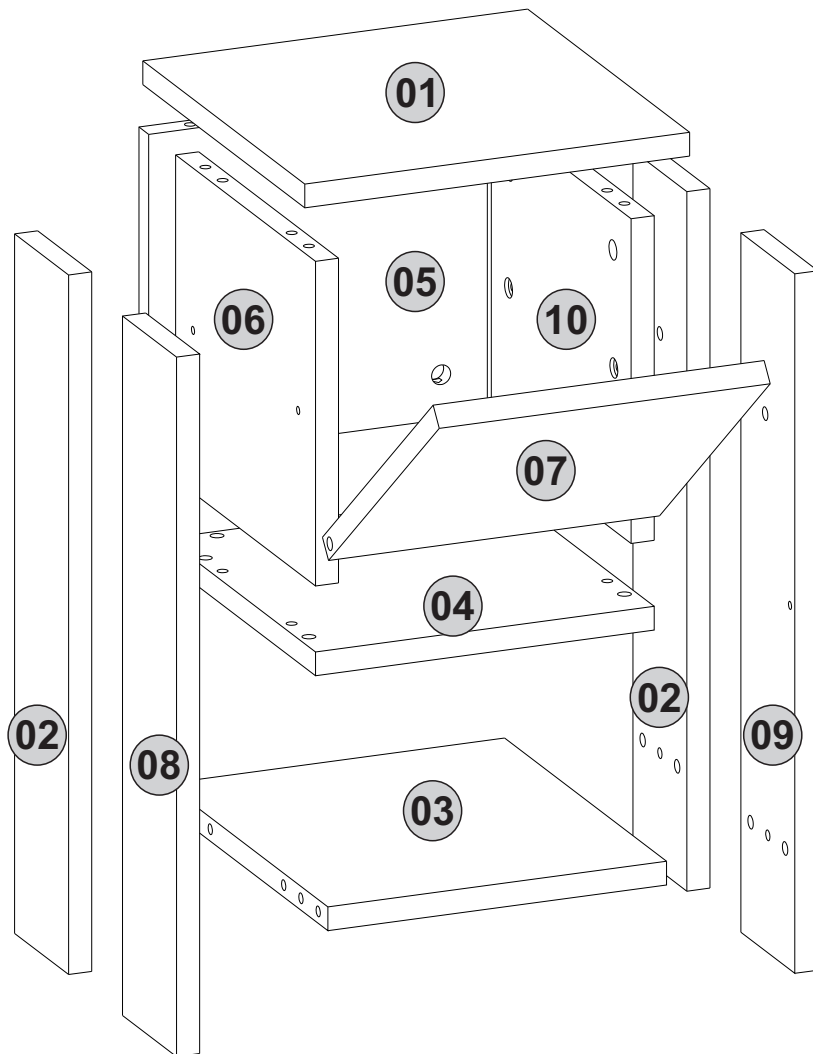

1. step

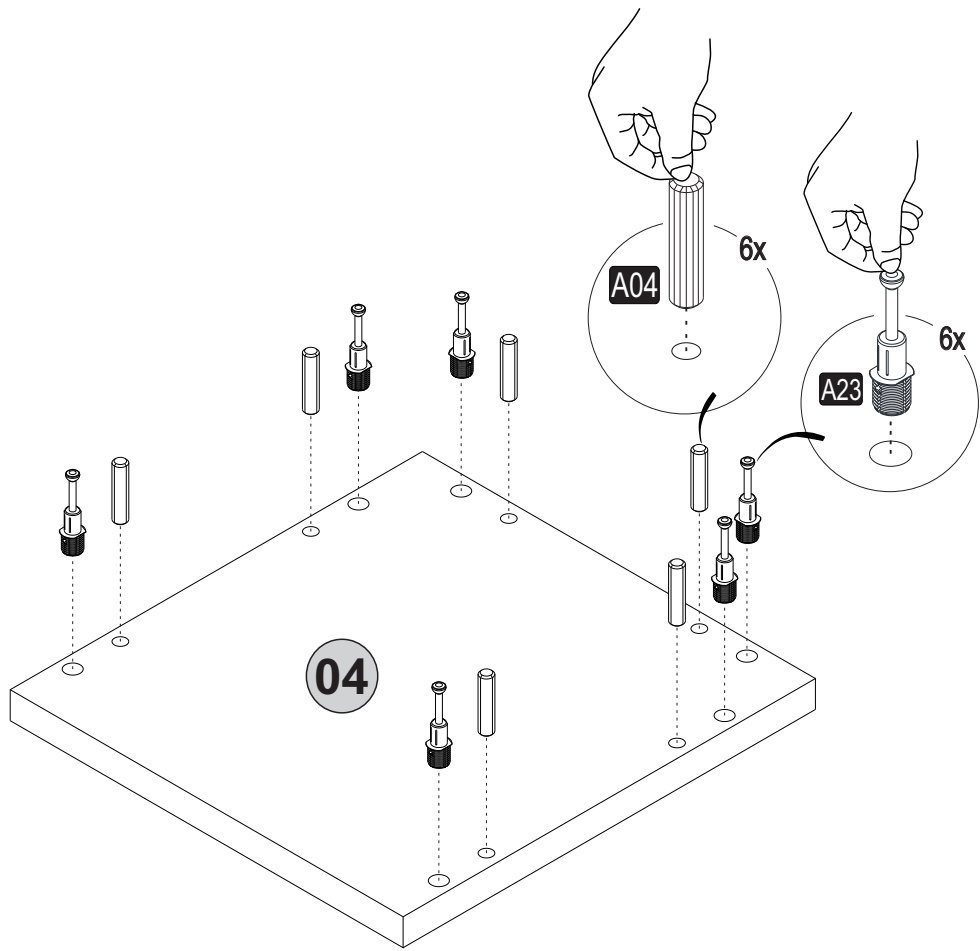

2. step

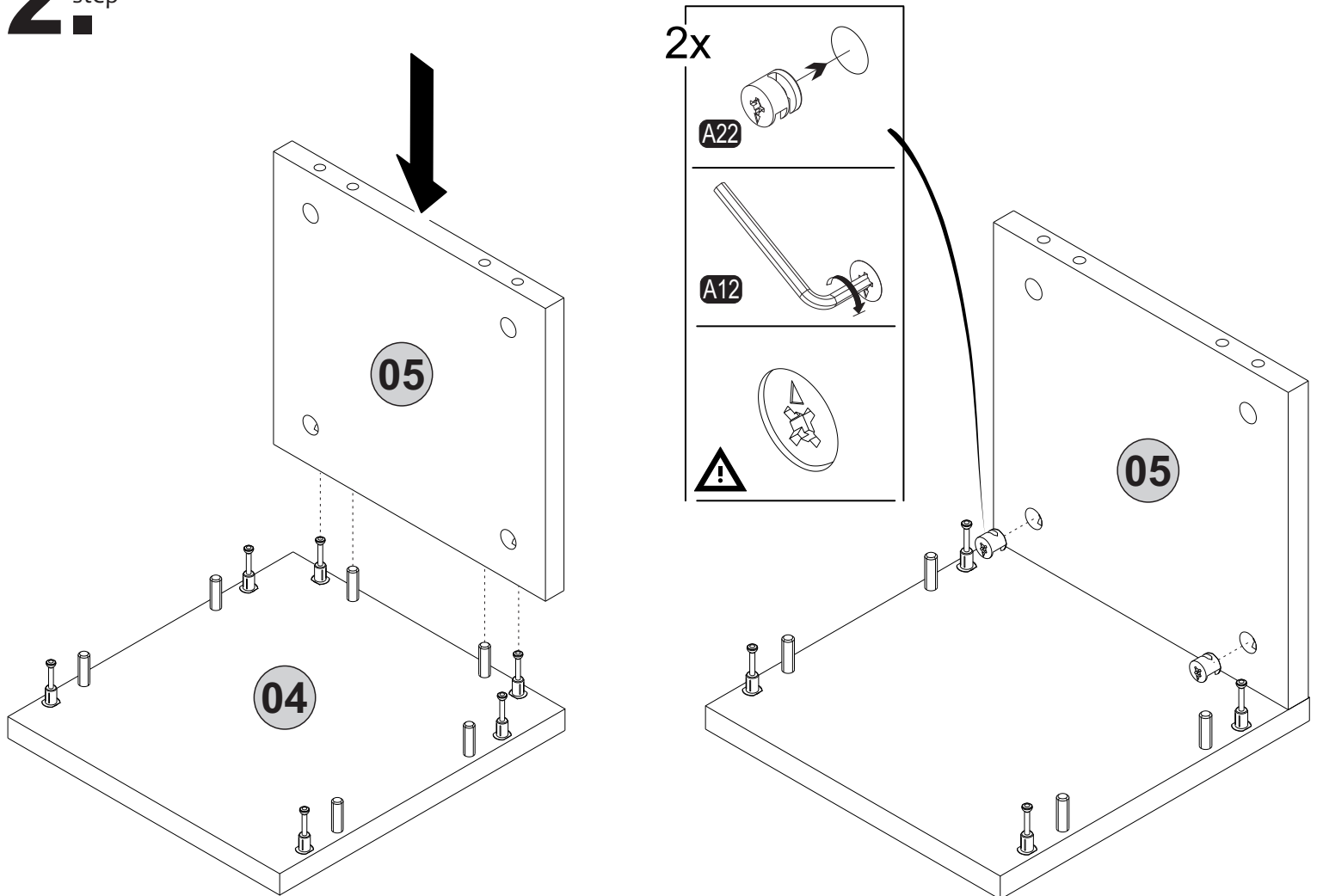

3. step

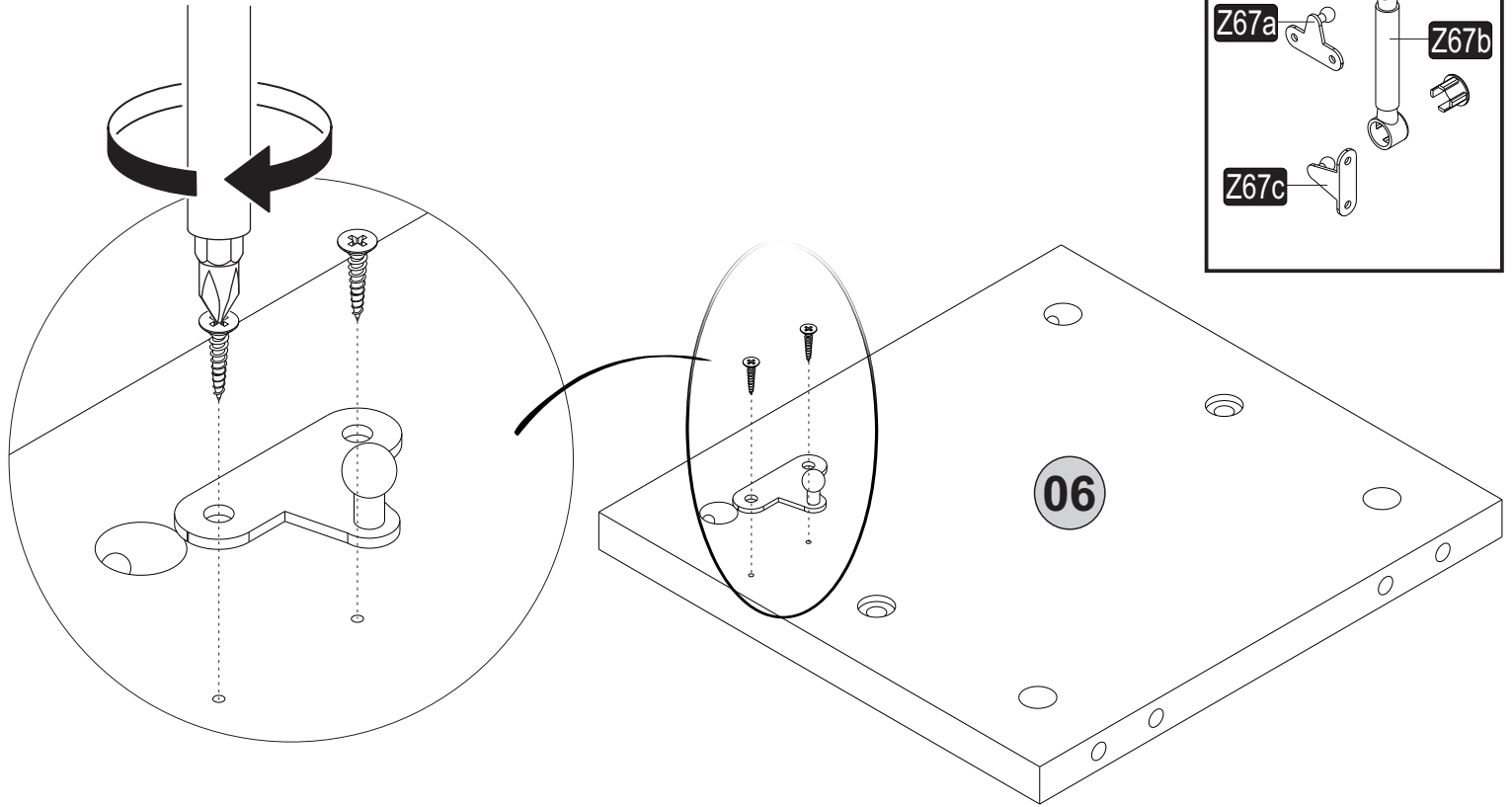

4. step

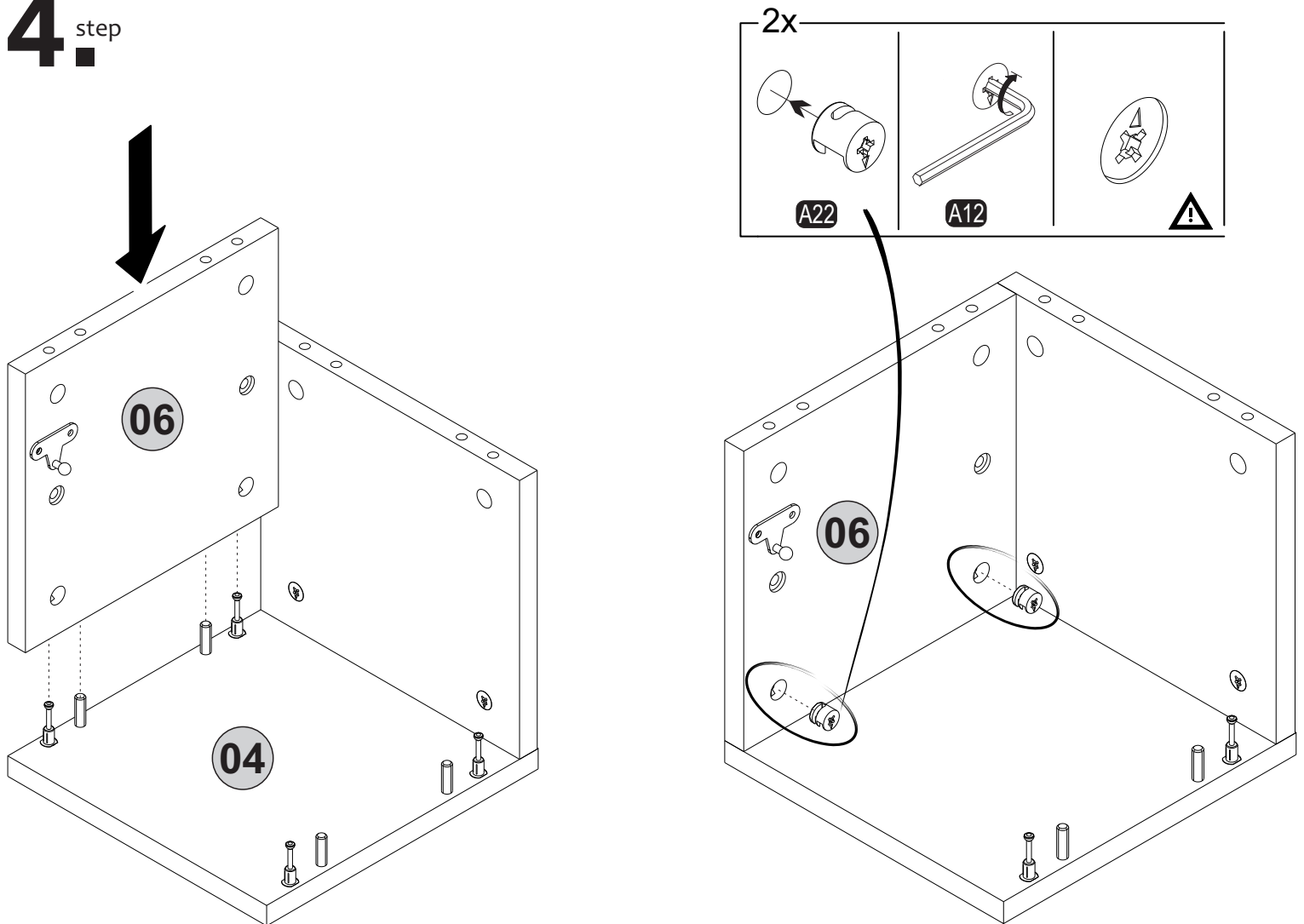

5. step

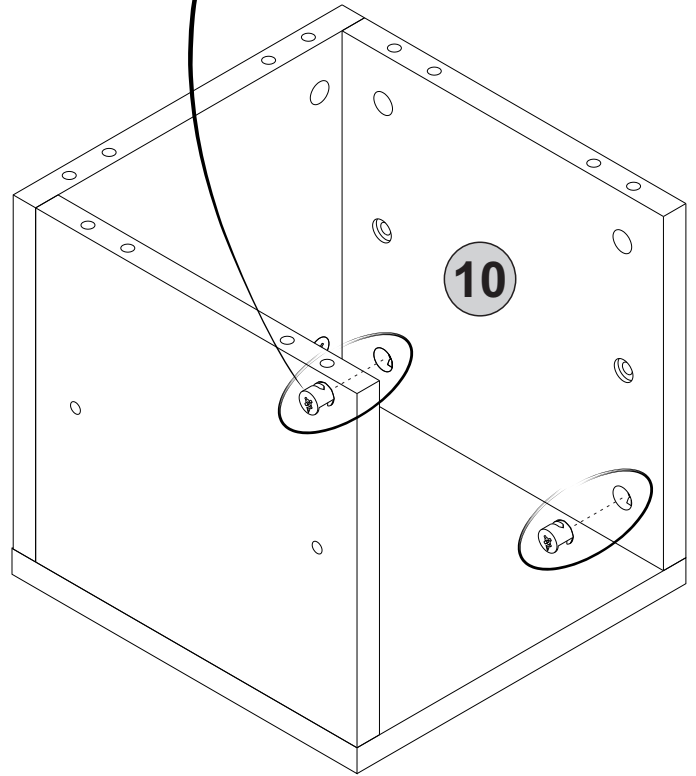
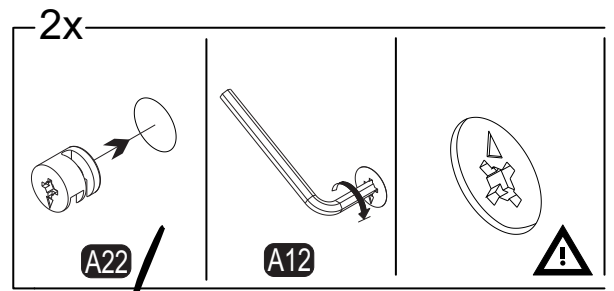
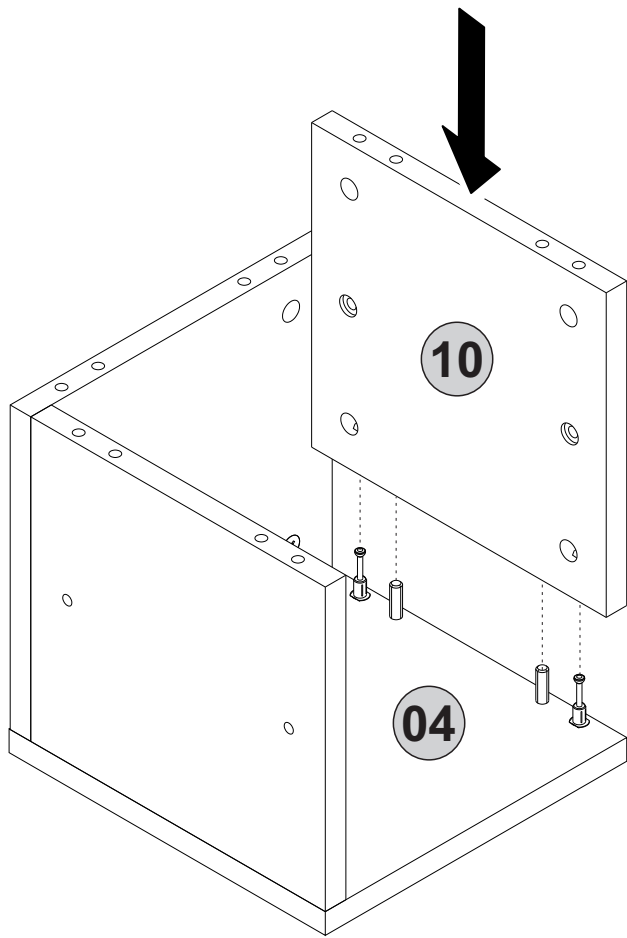

6. step

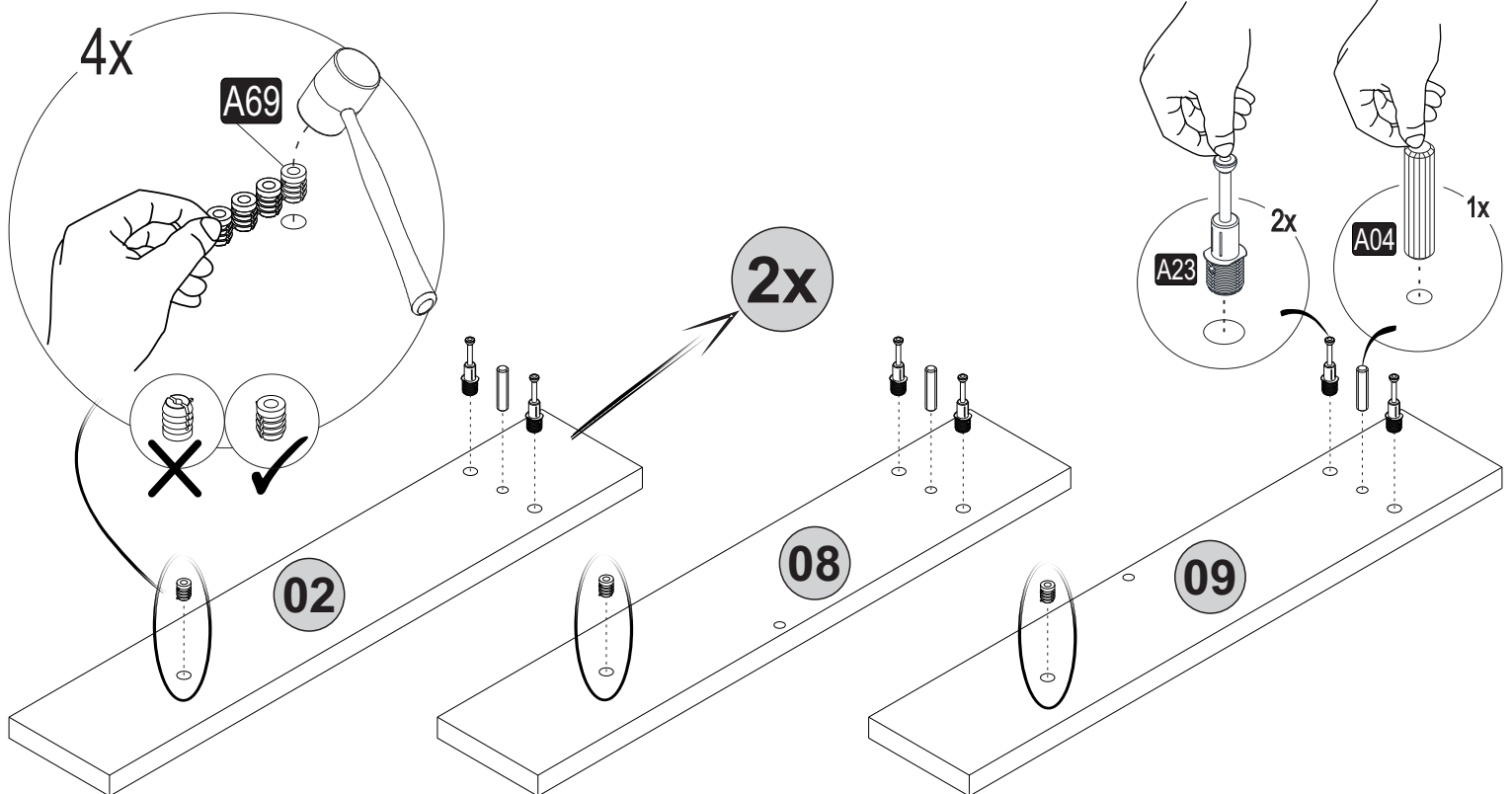

7. step

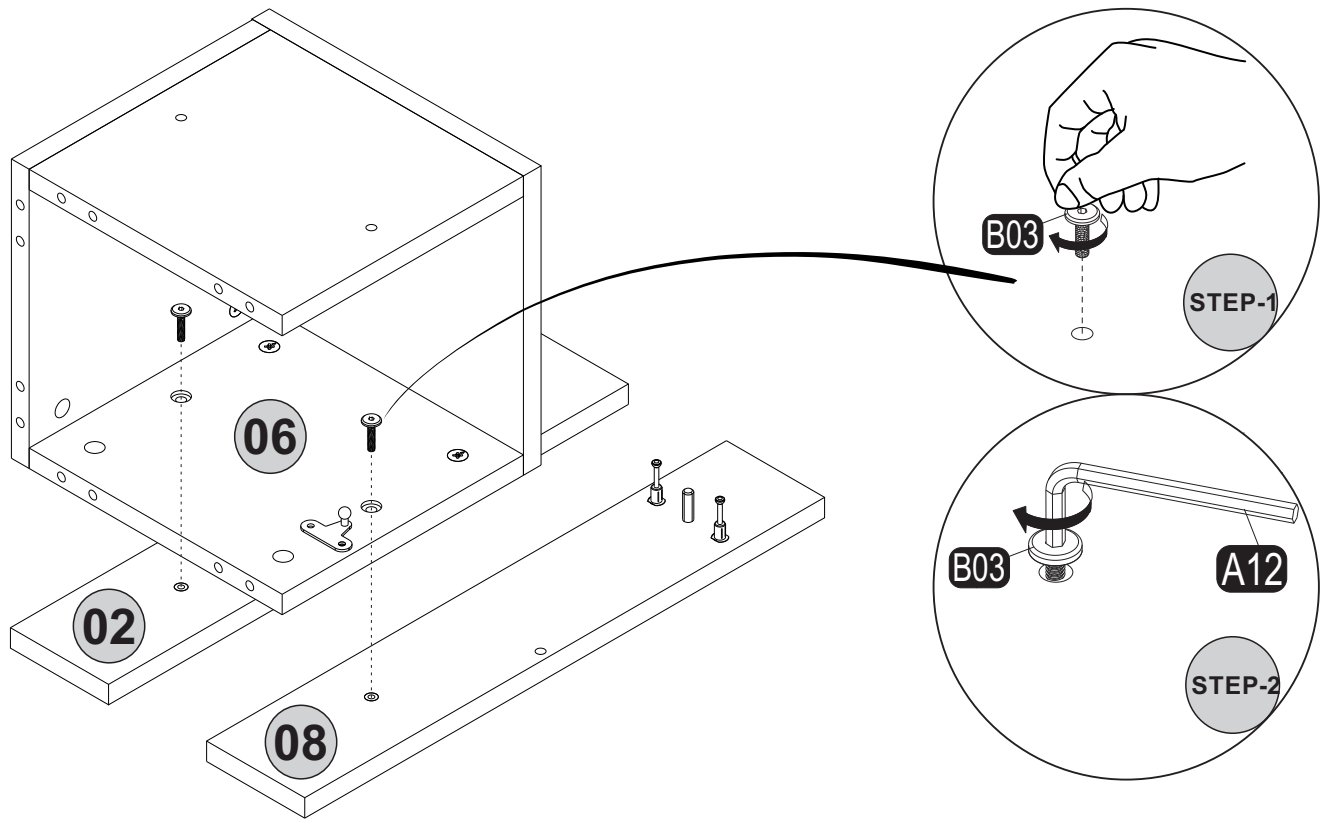

8. step

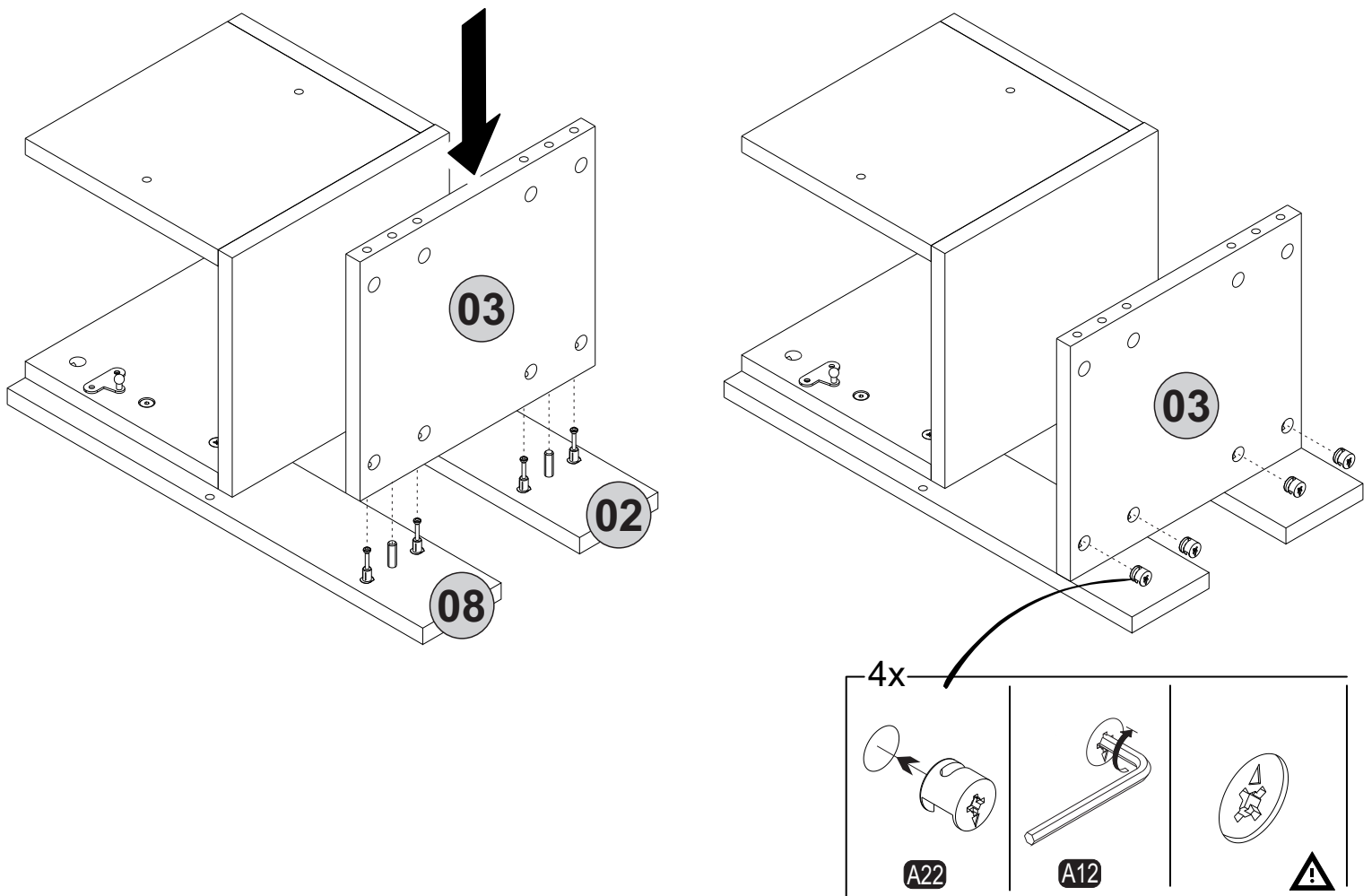

9^{step}

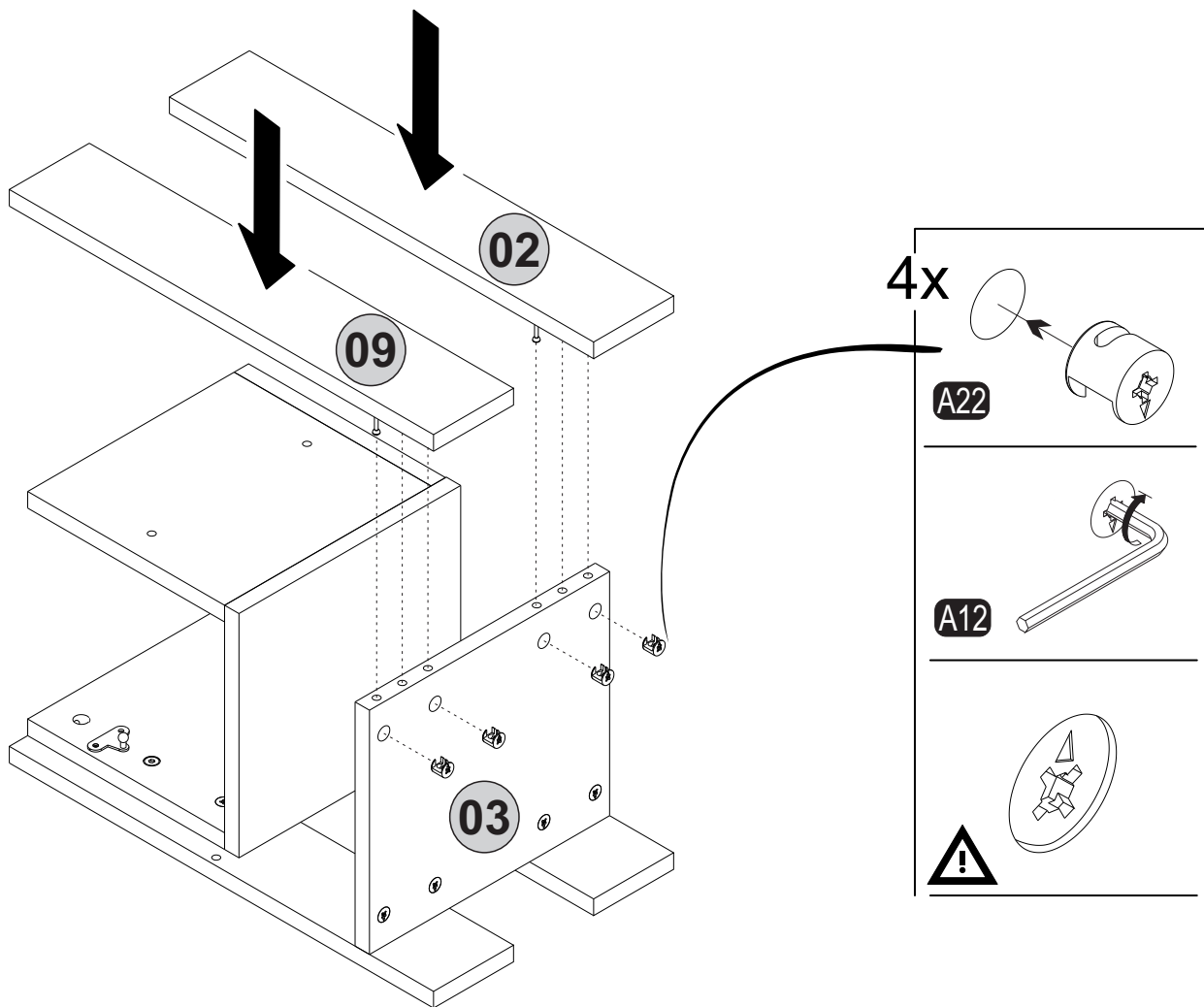

10^{step}

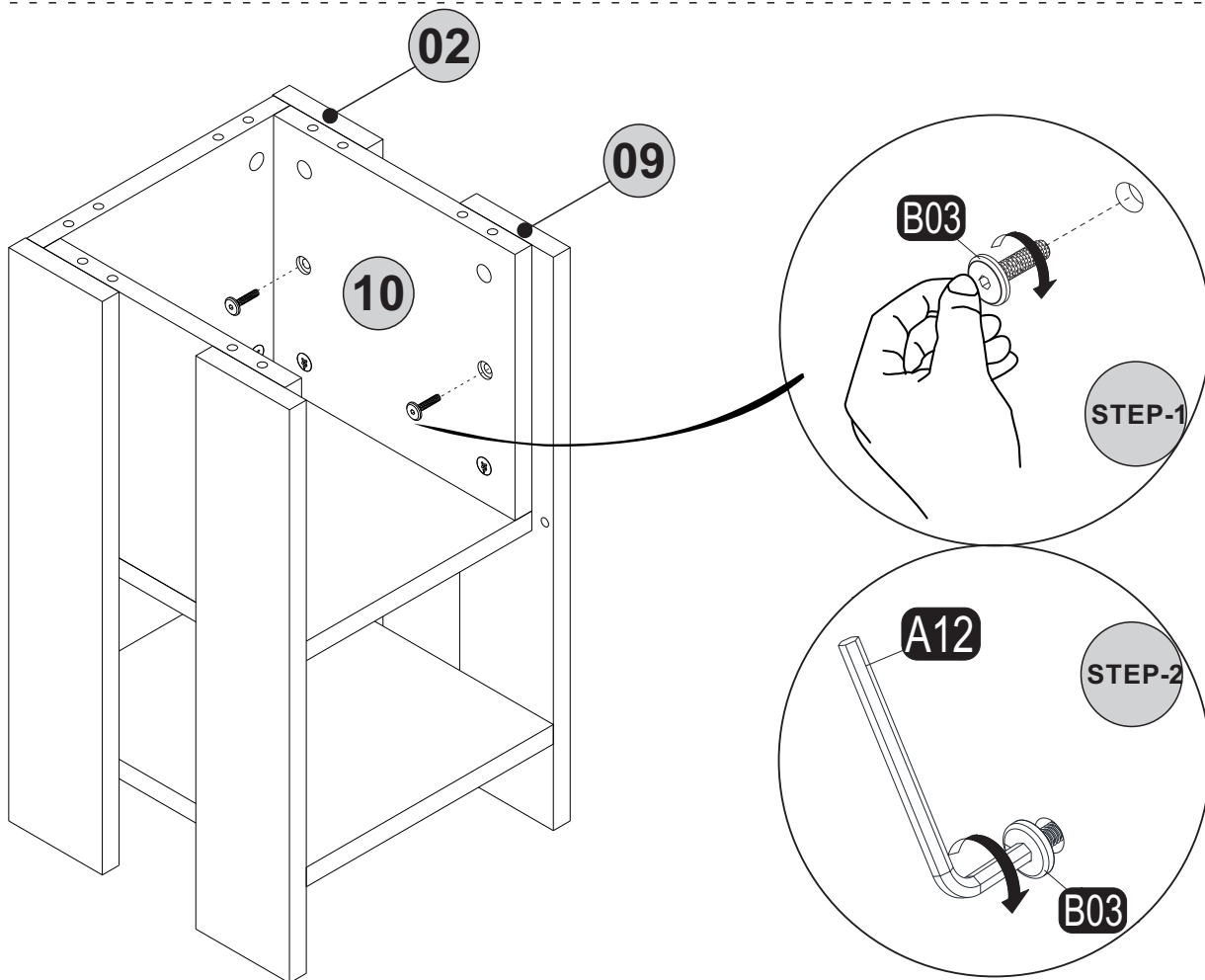

11. step

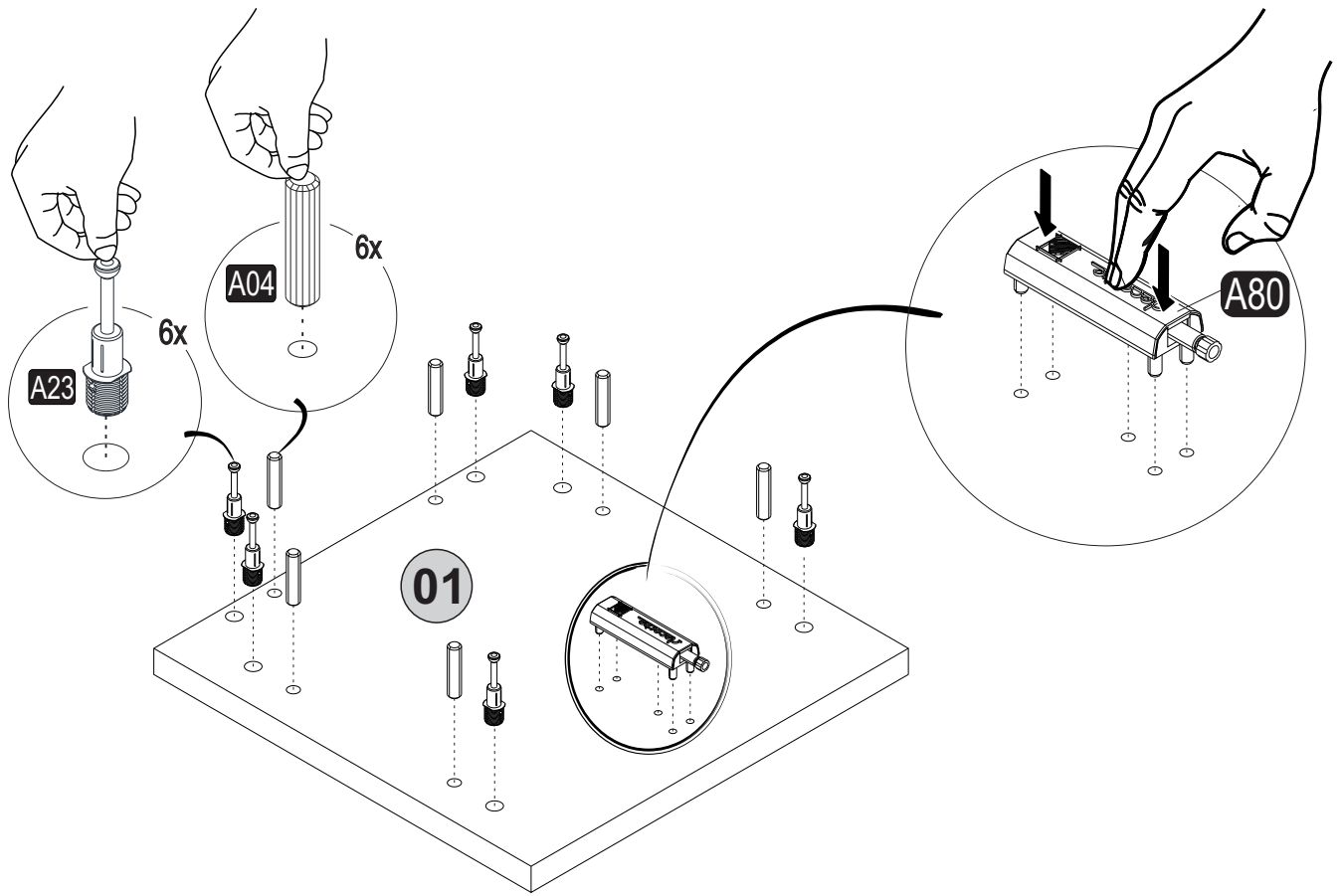

12. step

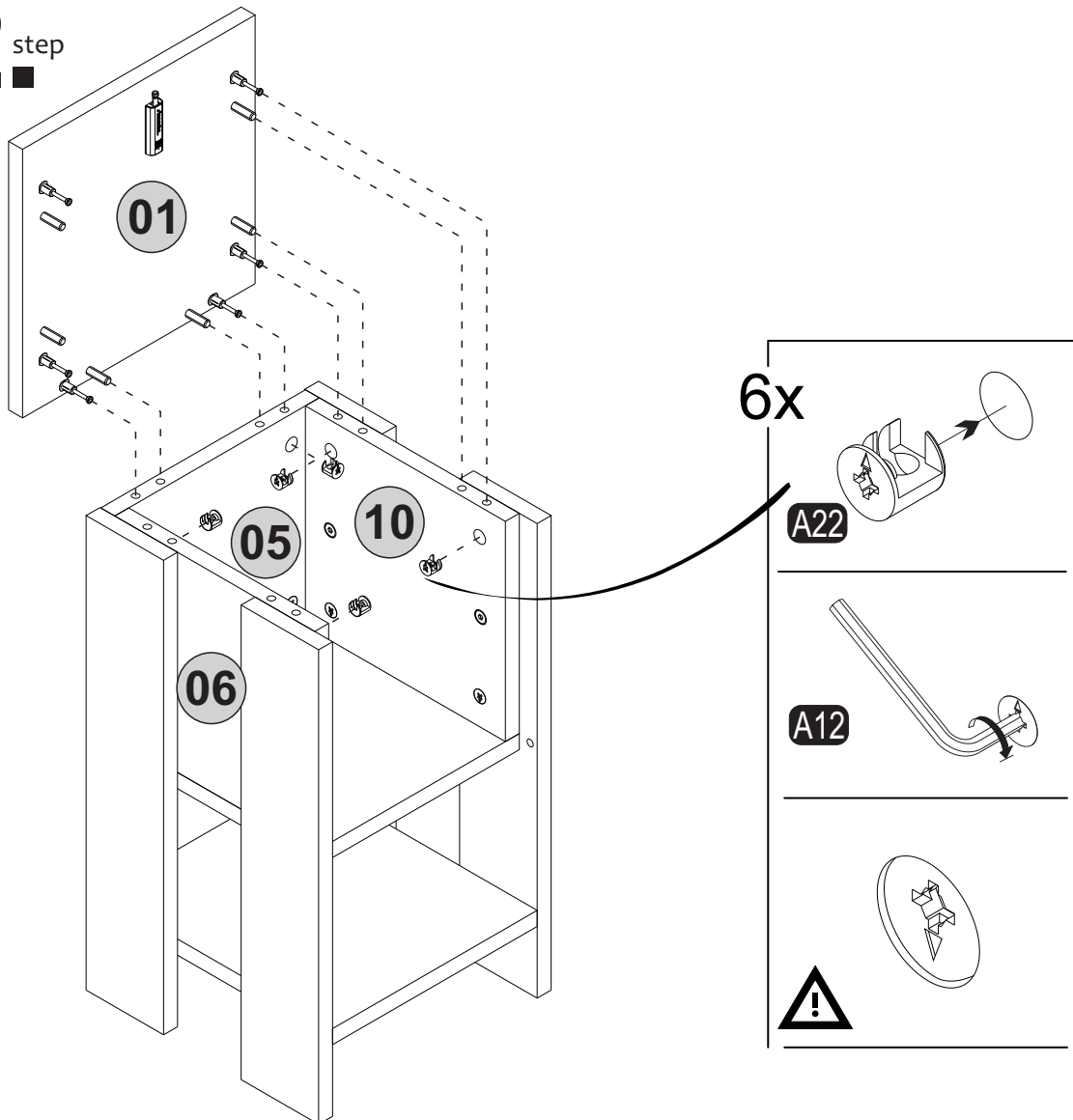

13. step

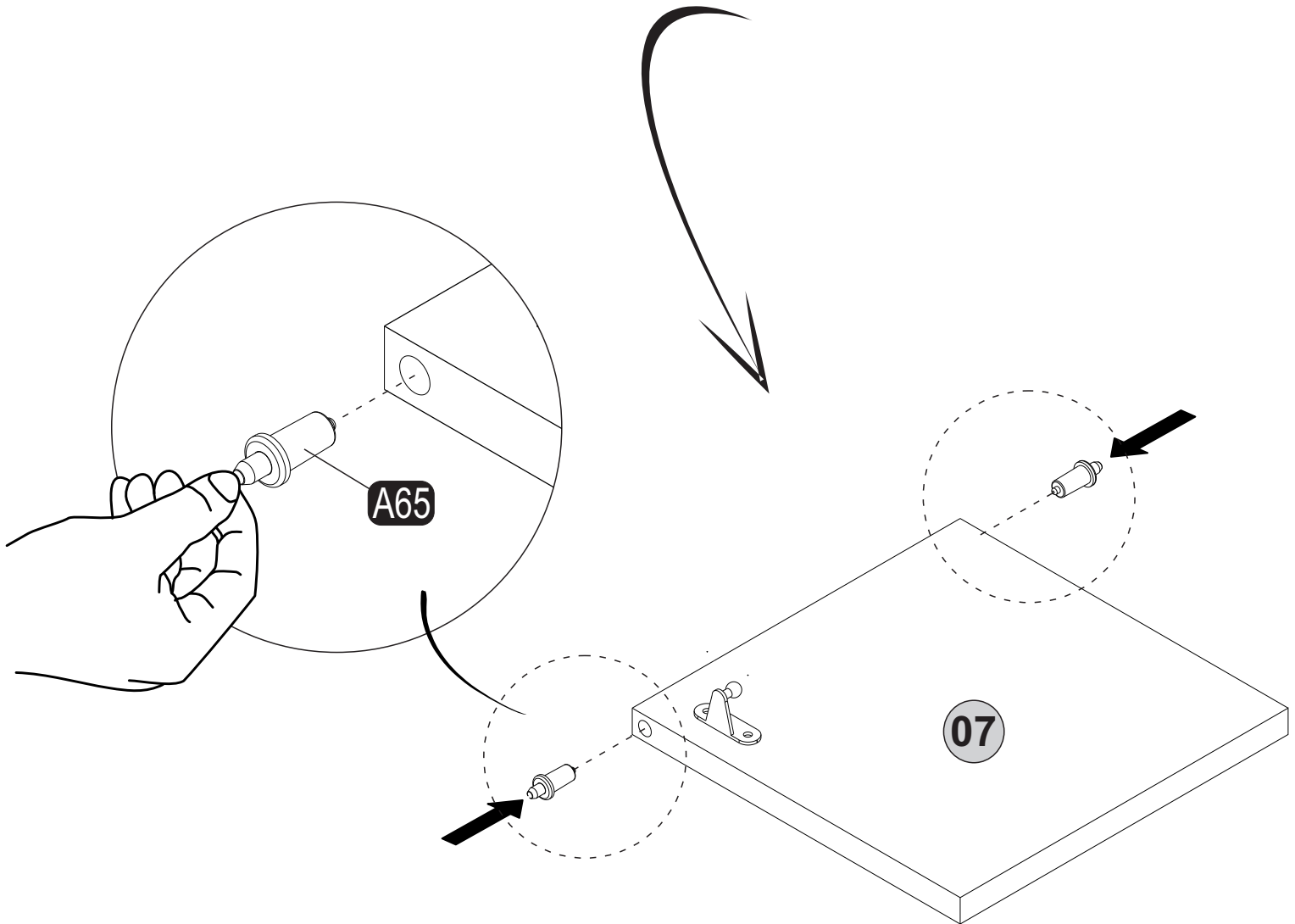
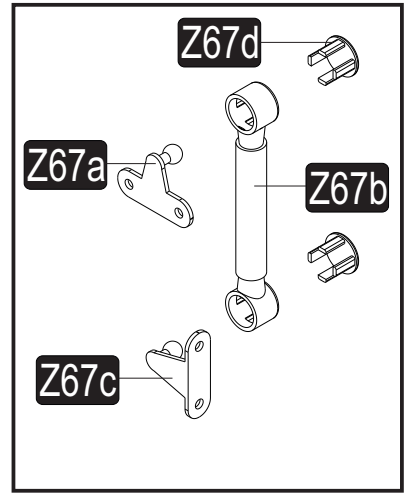
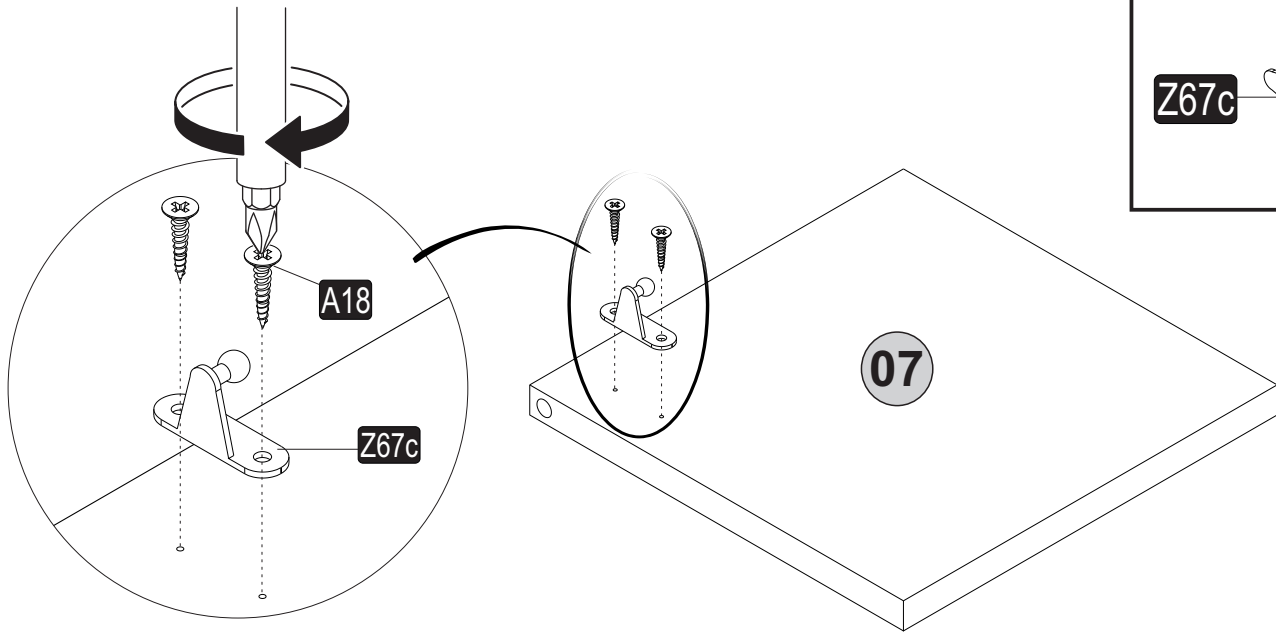

14.^{step}

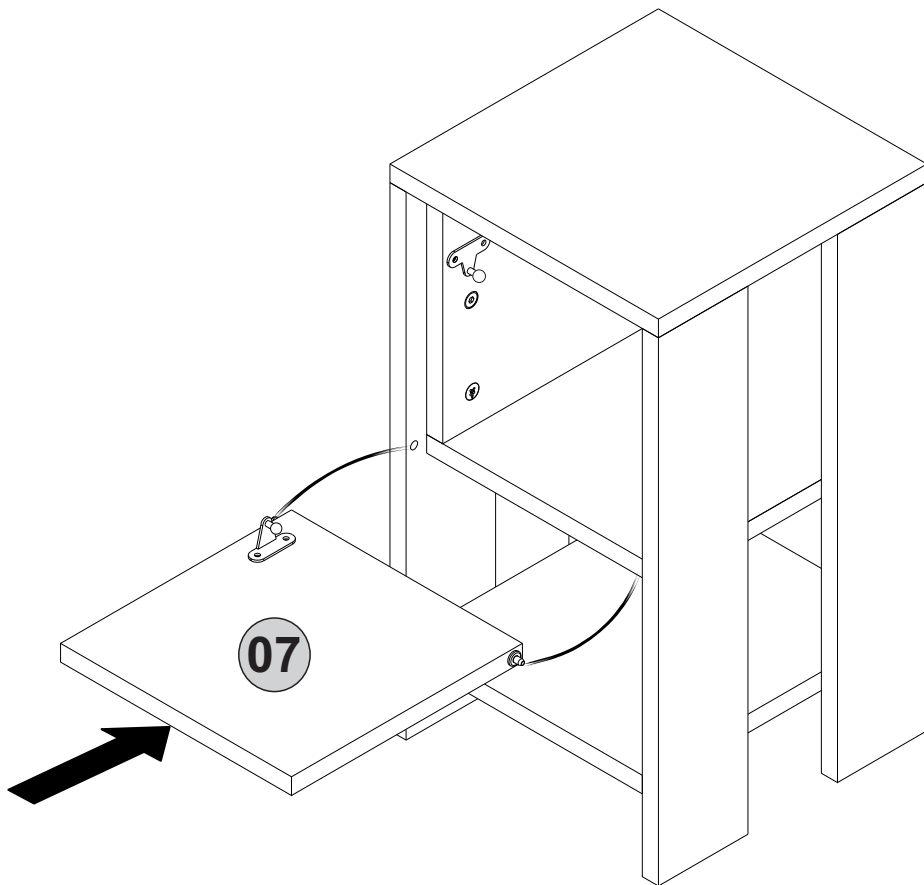
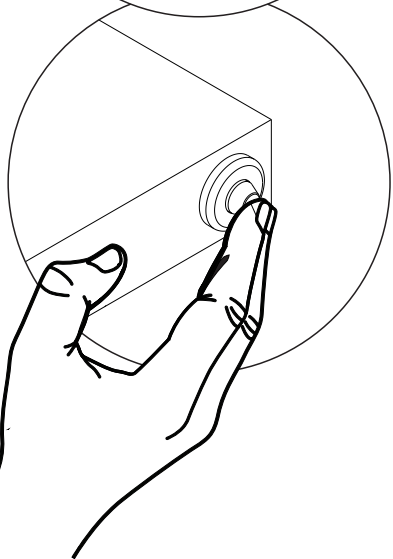
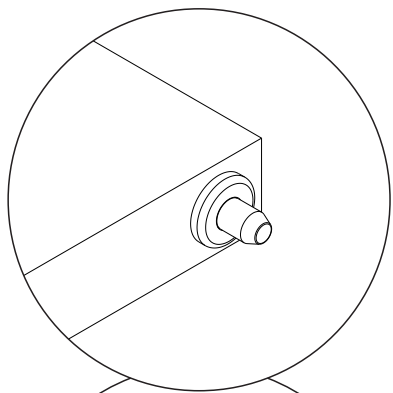

15.^{step}

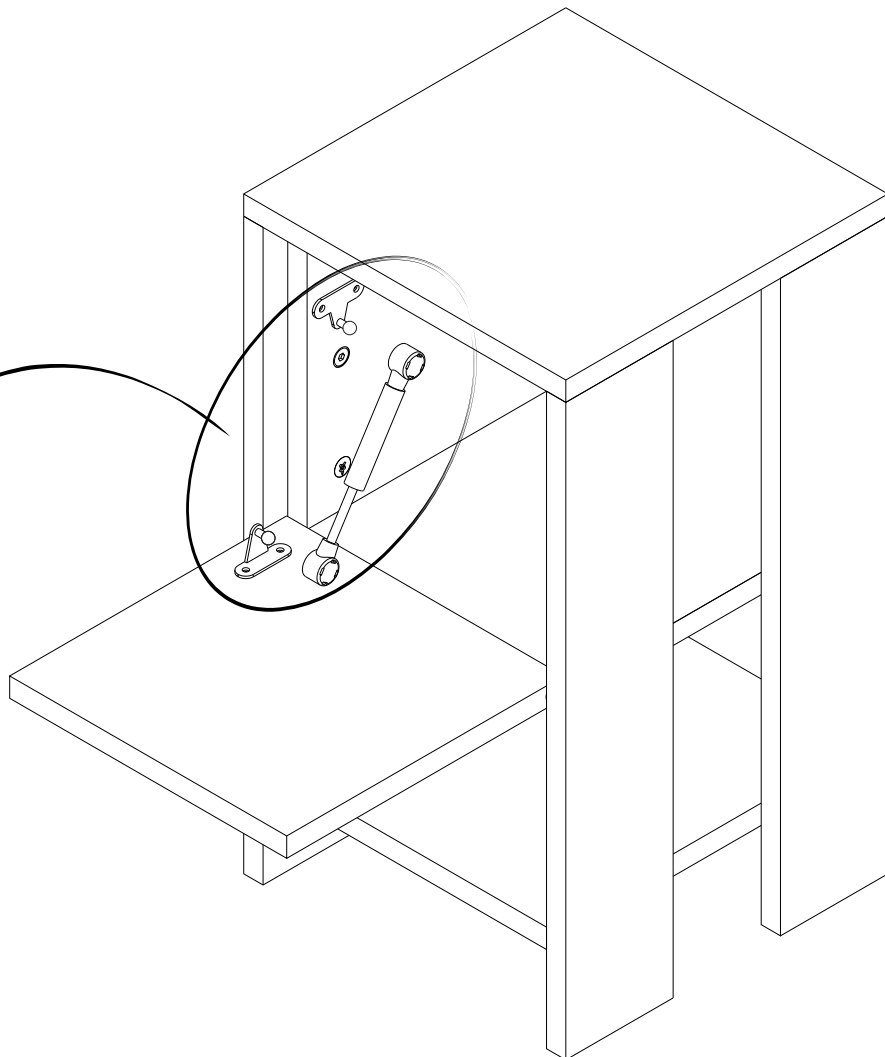
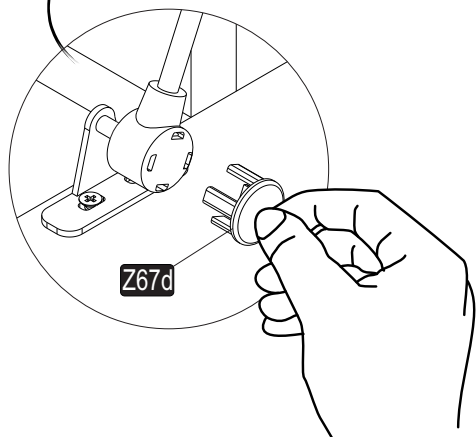
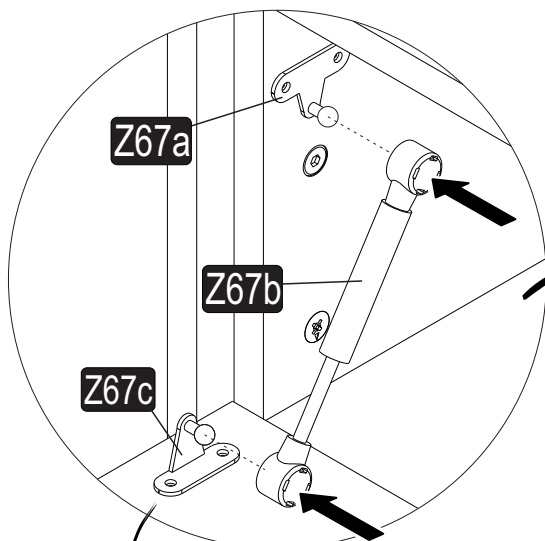

16^{step}

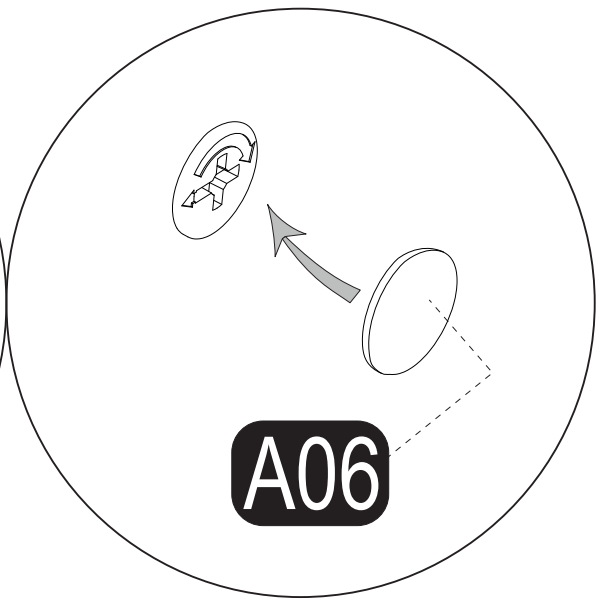
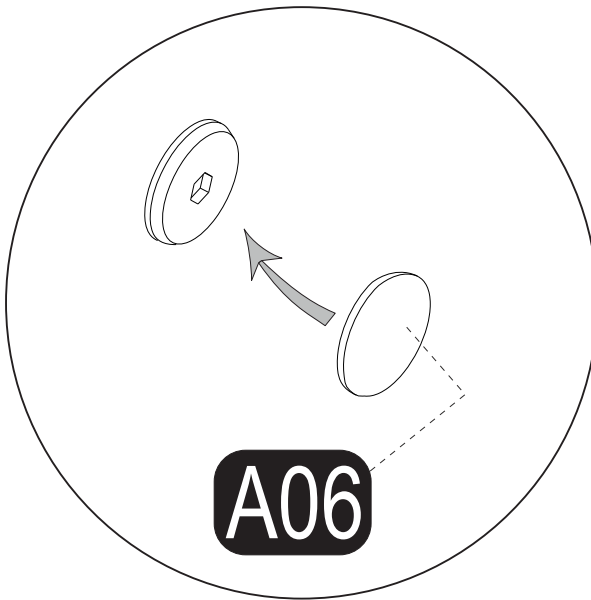
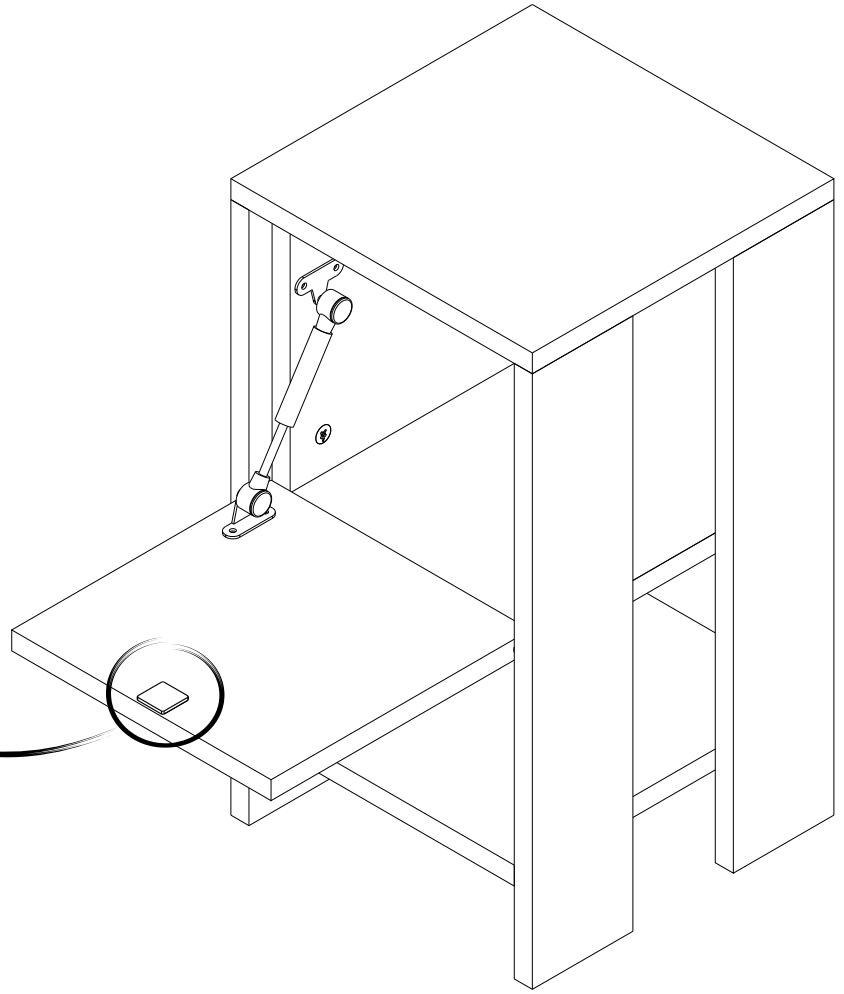
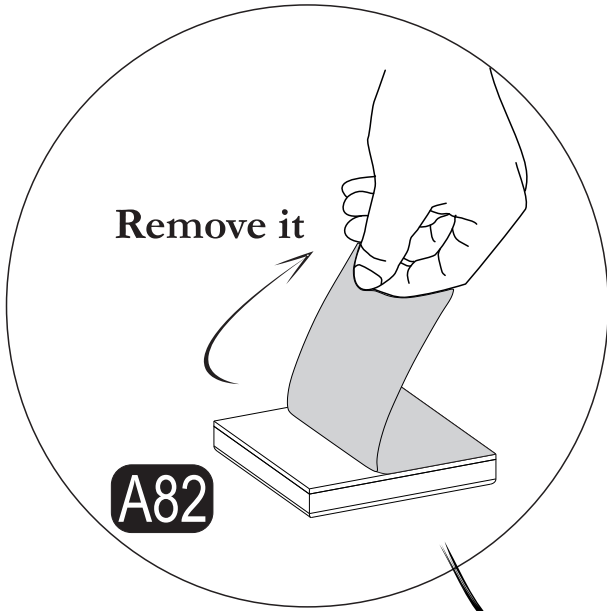

17. step

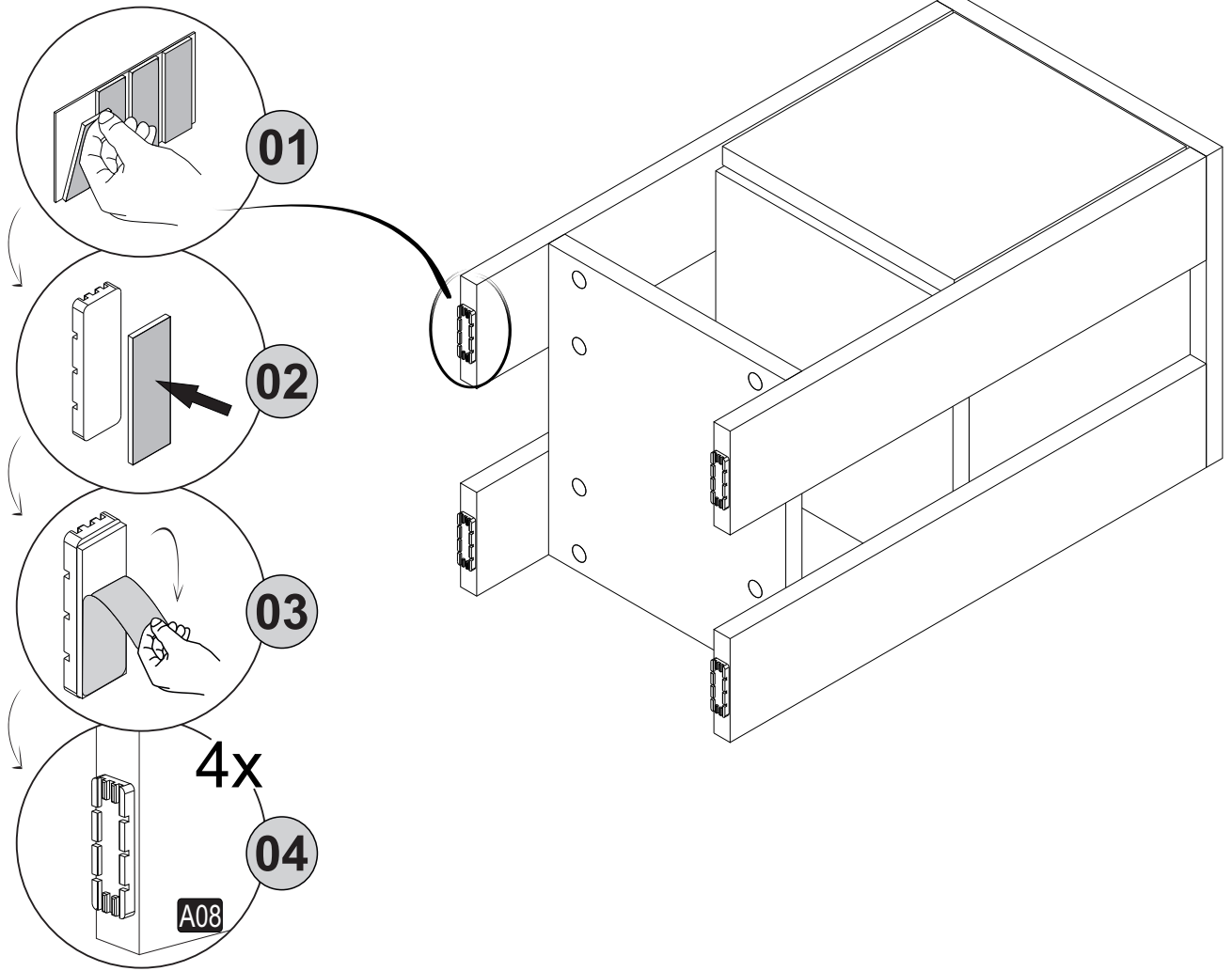

18. step

