

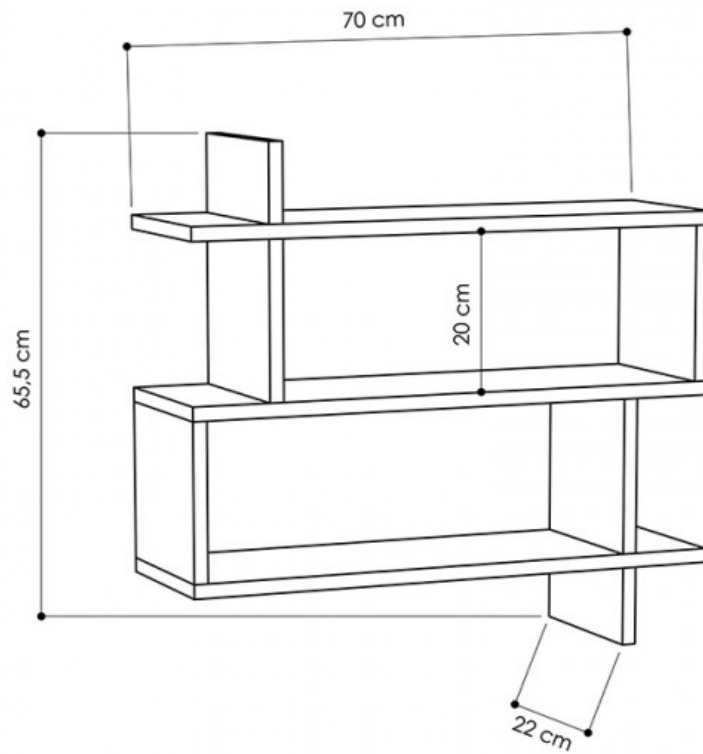







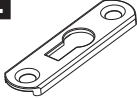

GP037-0037,3

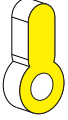

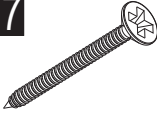
A13  50mm 12x	A12  4 SW 1x	A32  60/16 2x	A11  3,5x30 4x	Z18  Gbdy 2x
A16  DbØ8 2x	A17  4X50 2x	A06  18mm 12x		

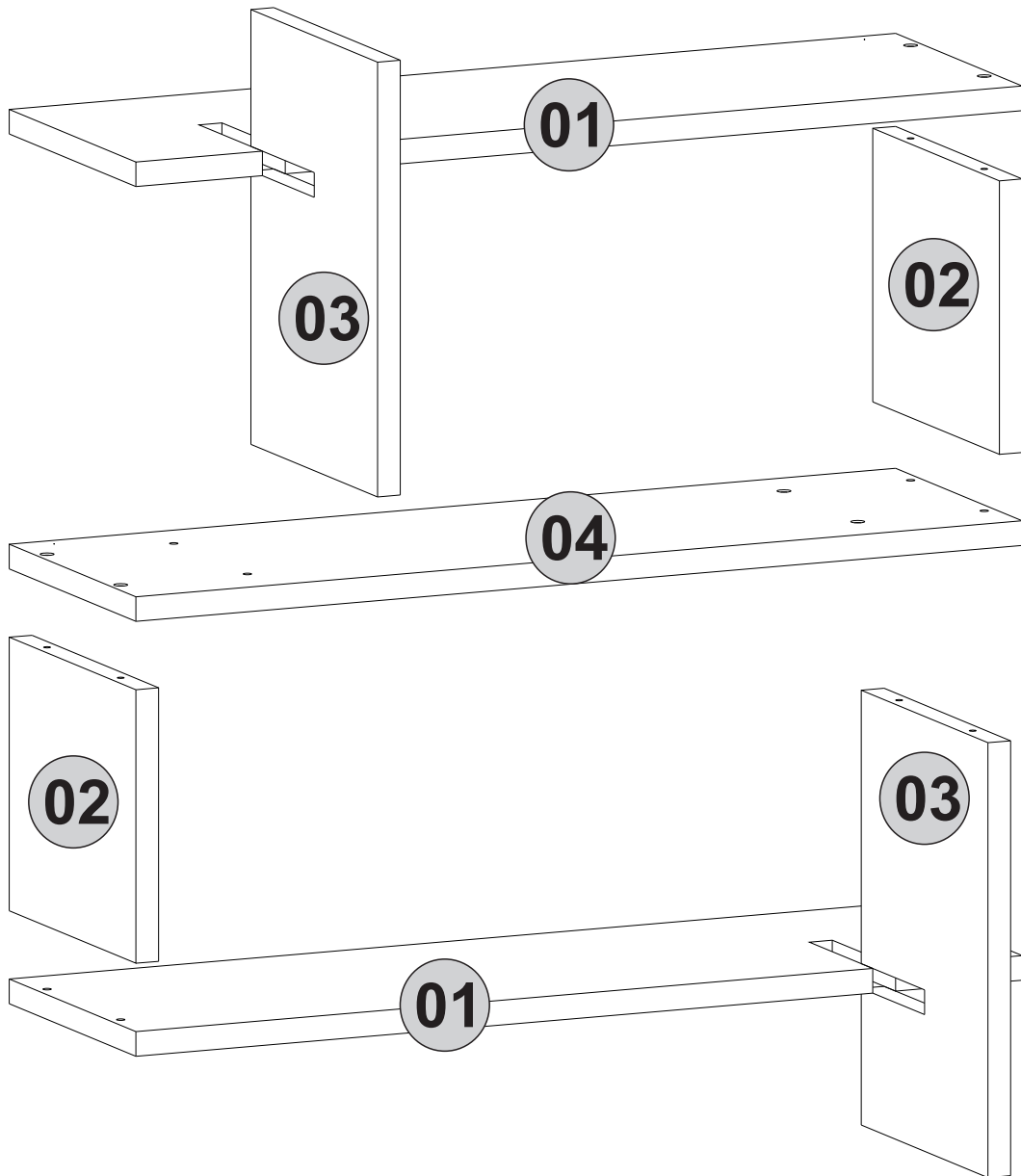

1. step

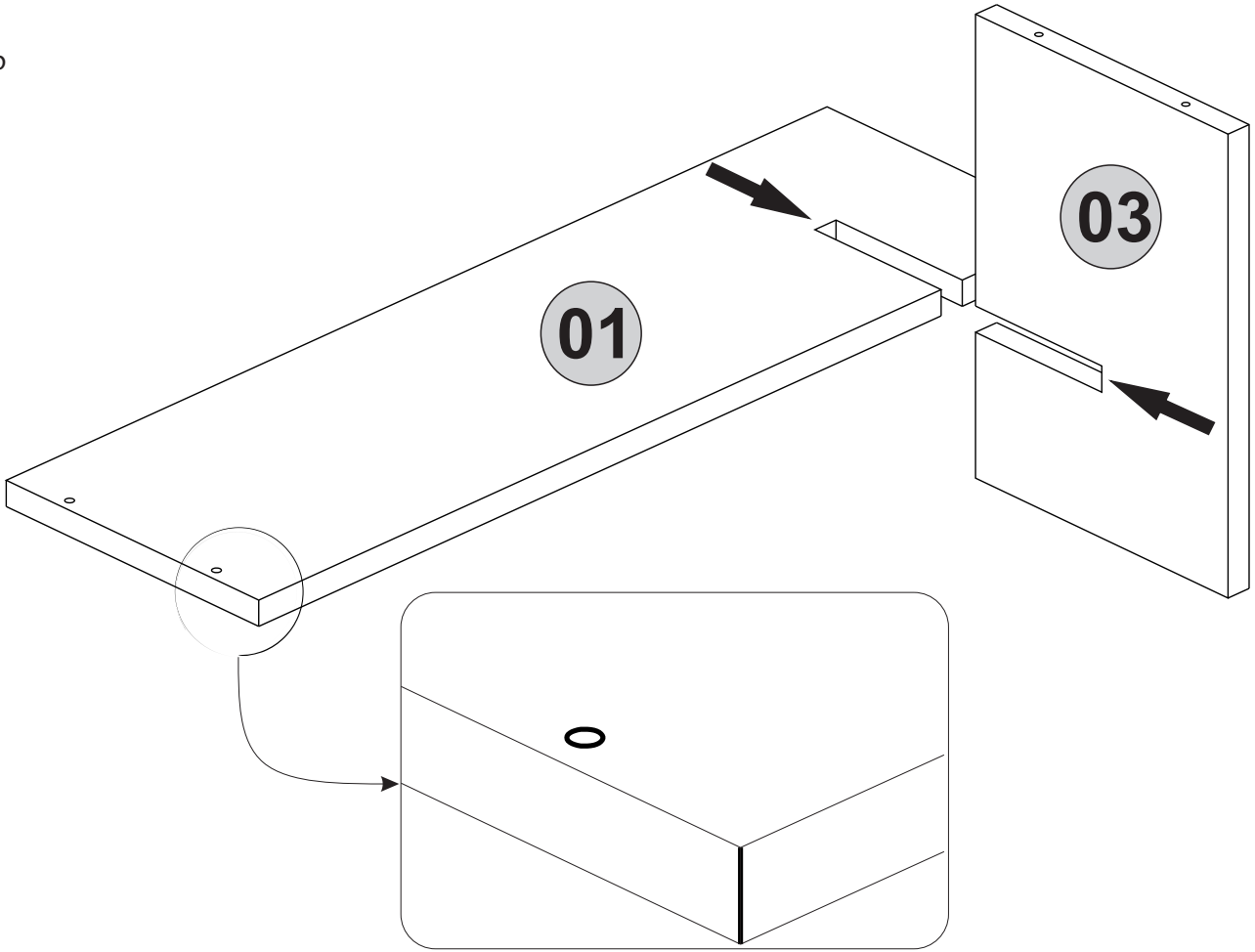

2. step

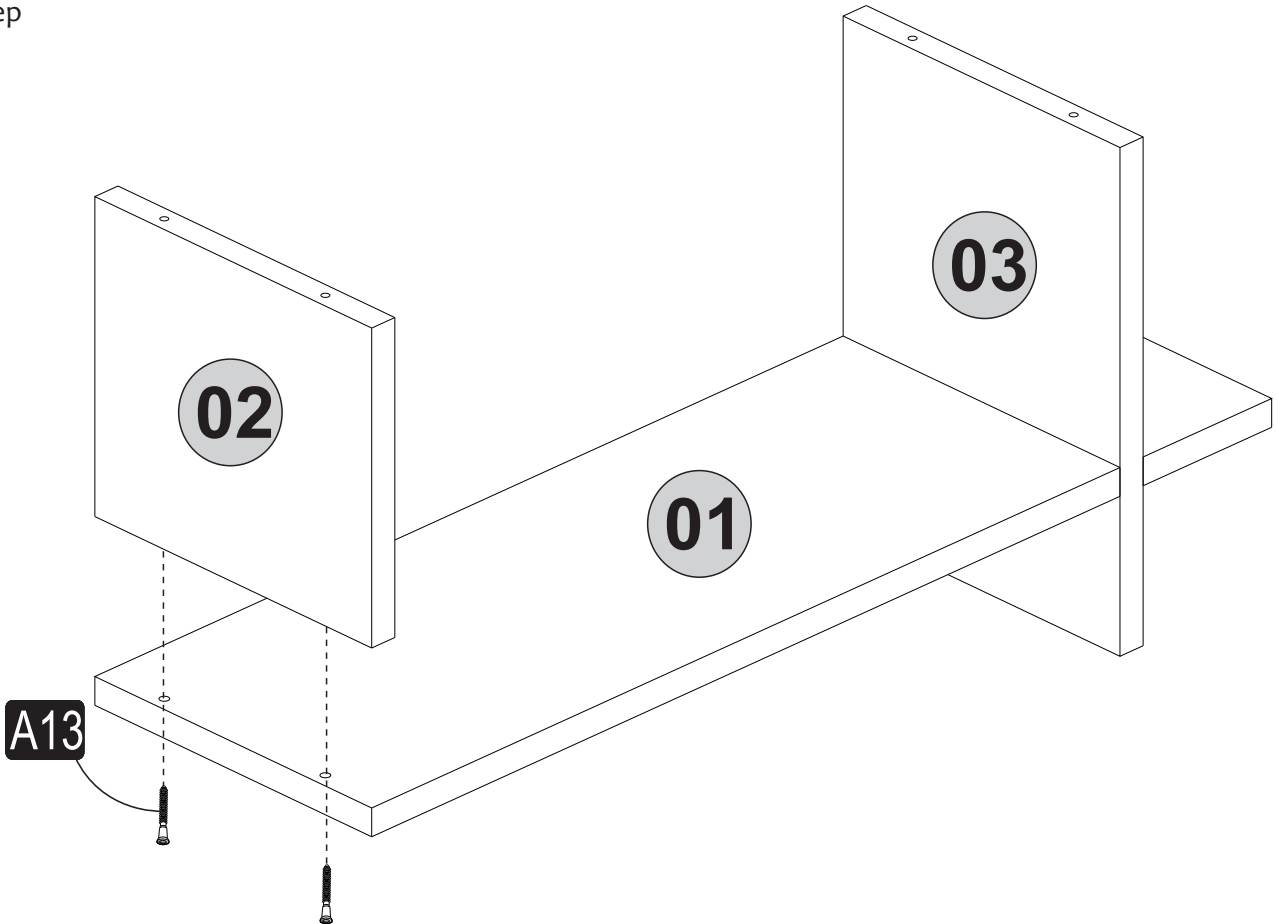

3^{step}

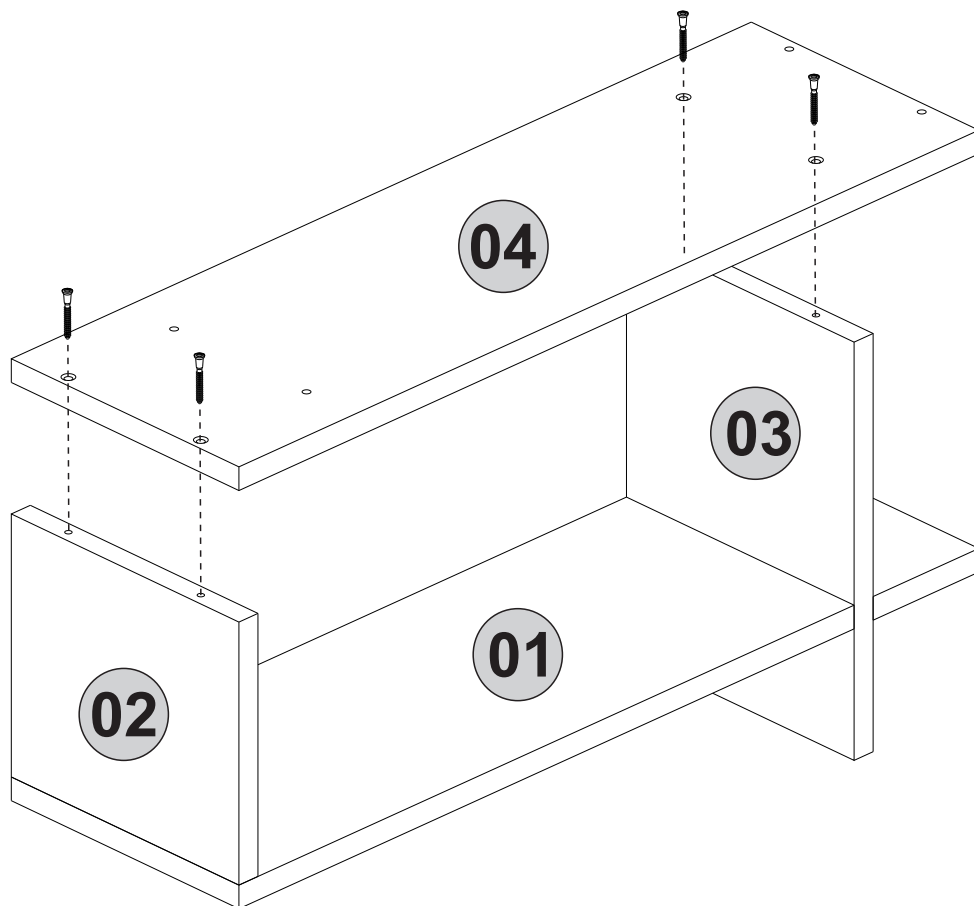

4^{step}

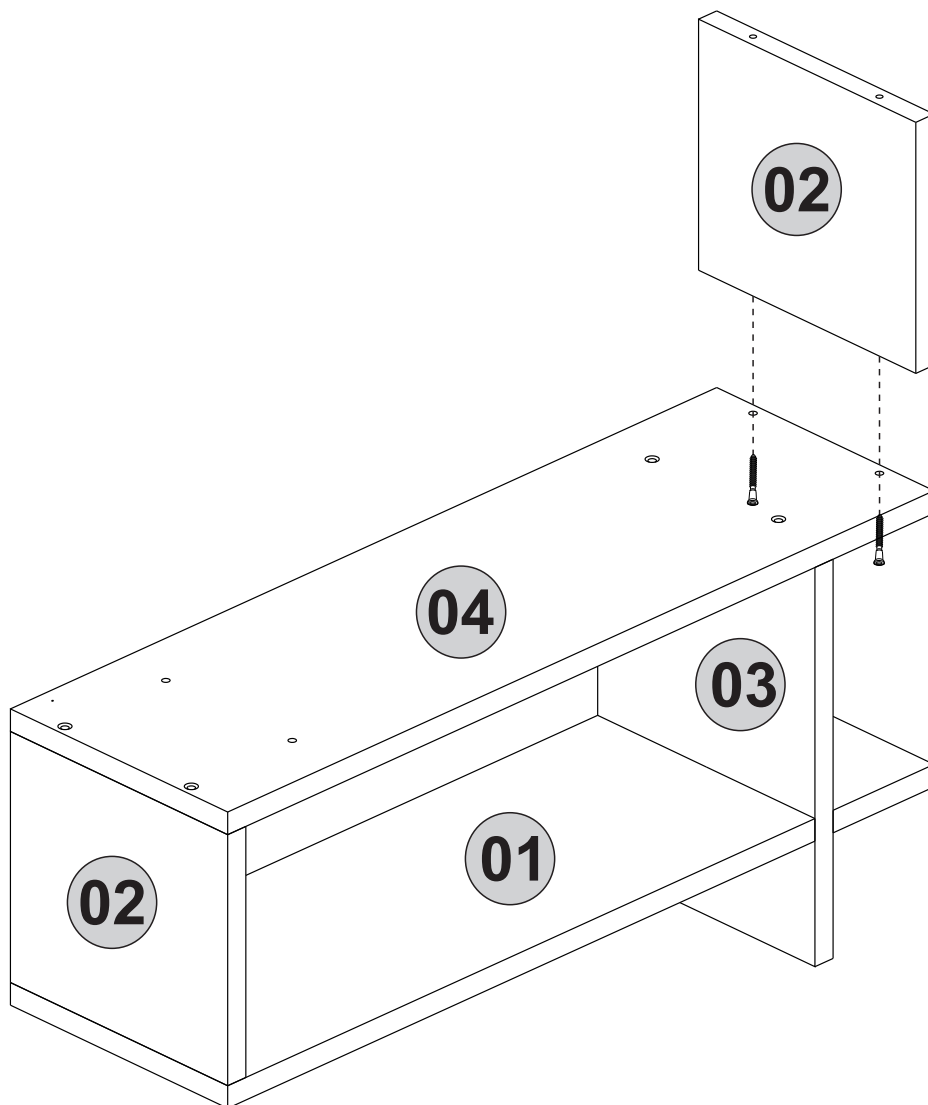

5 step

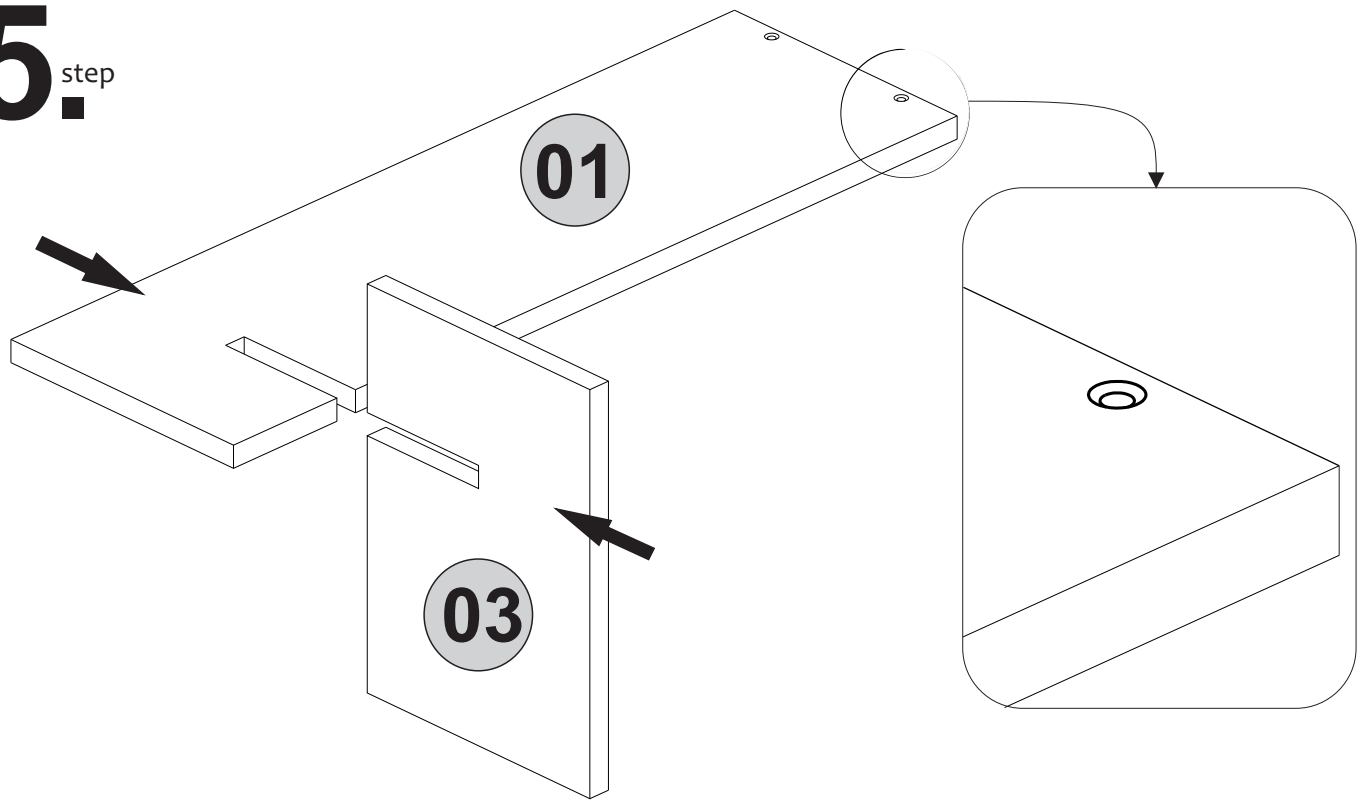

6 step

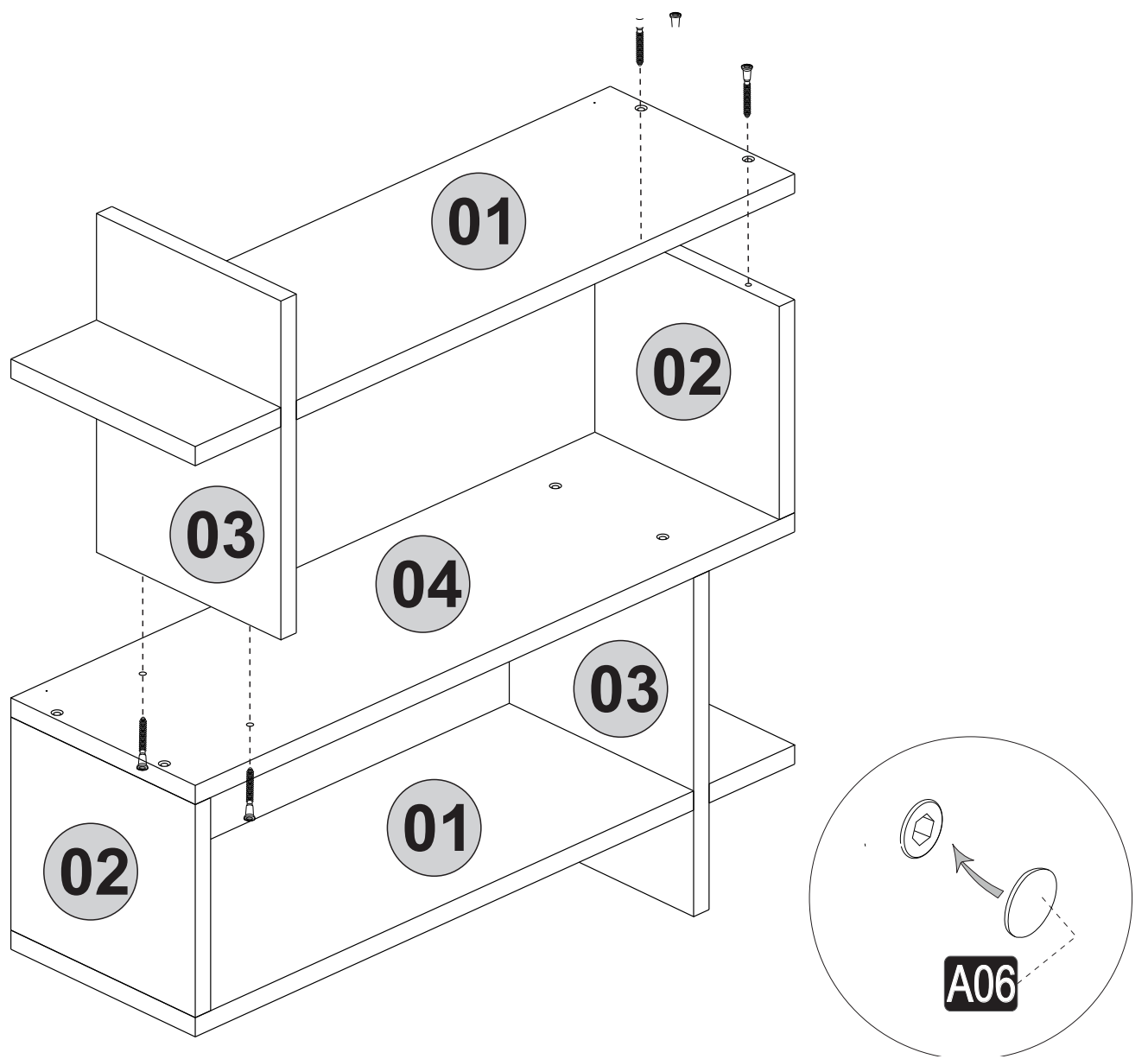

7 step

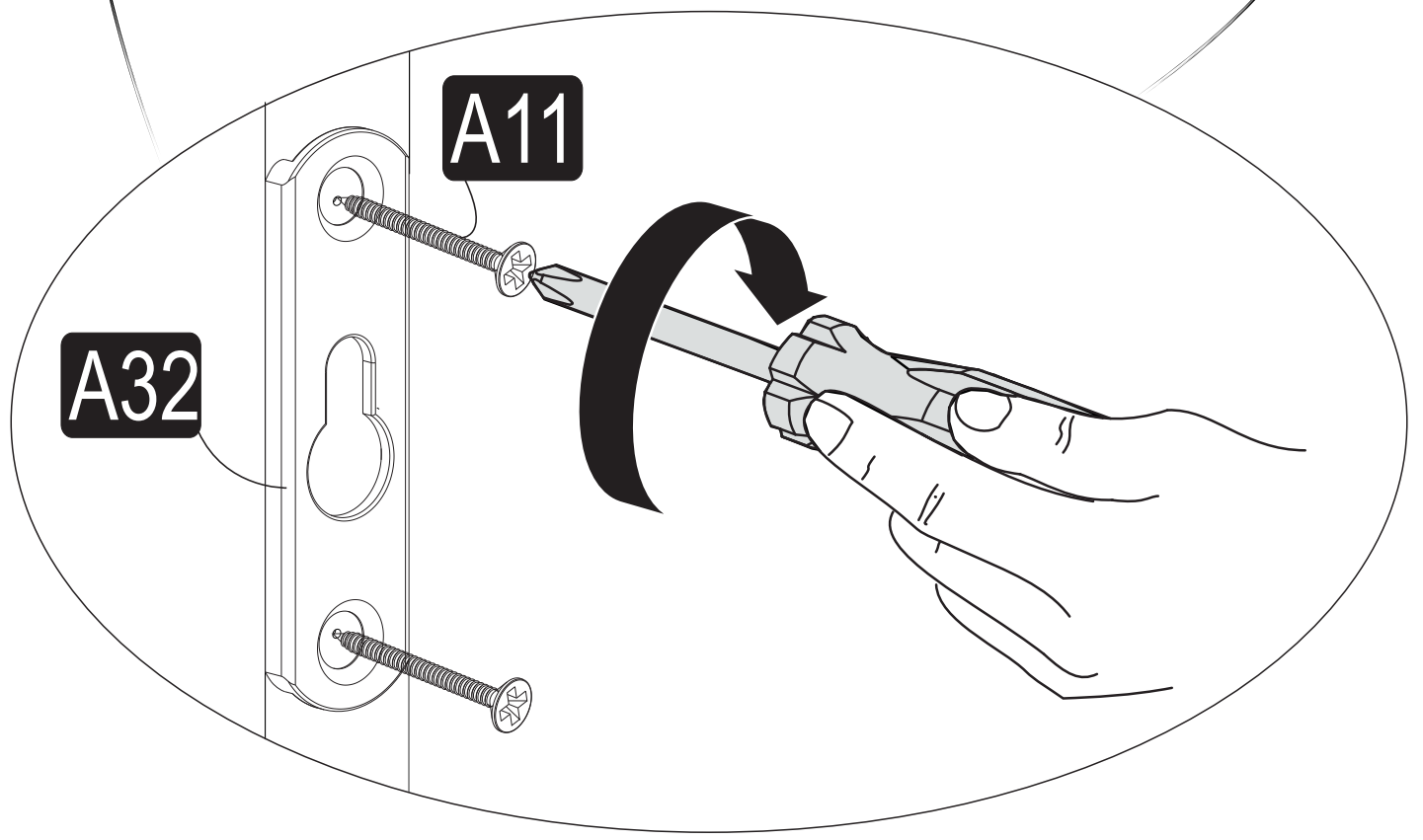
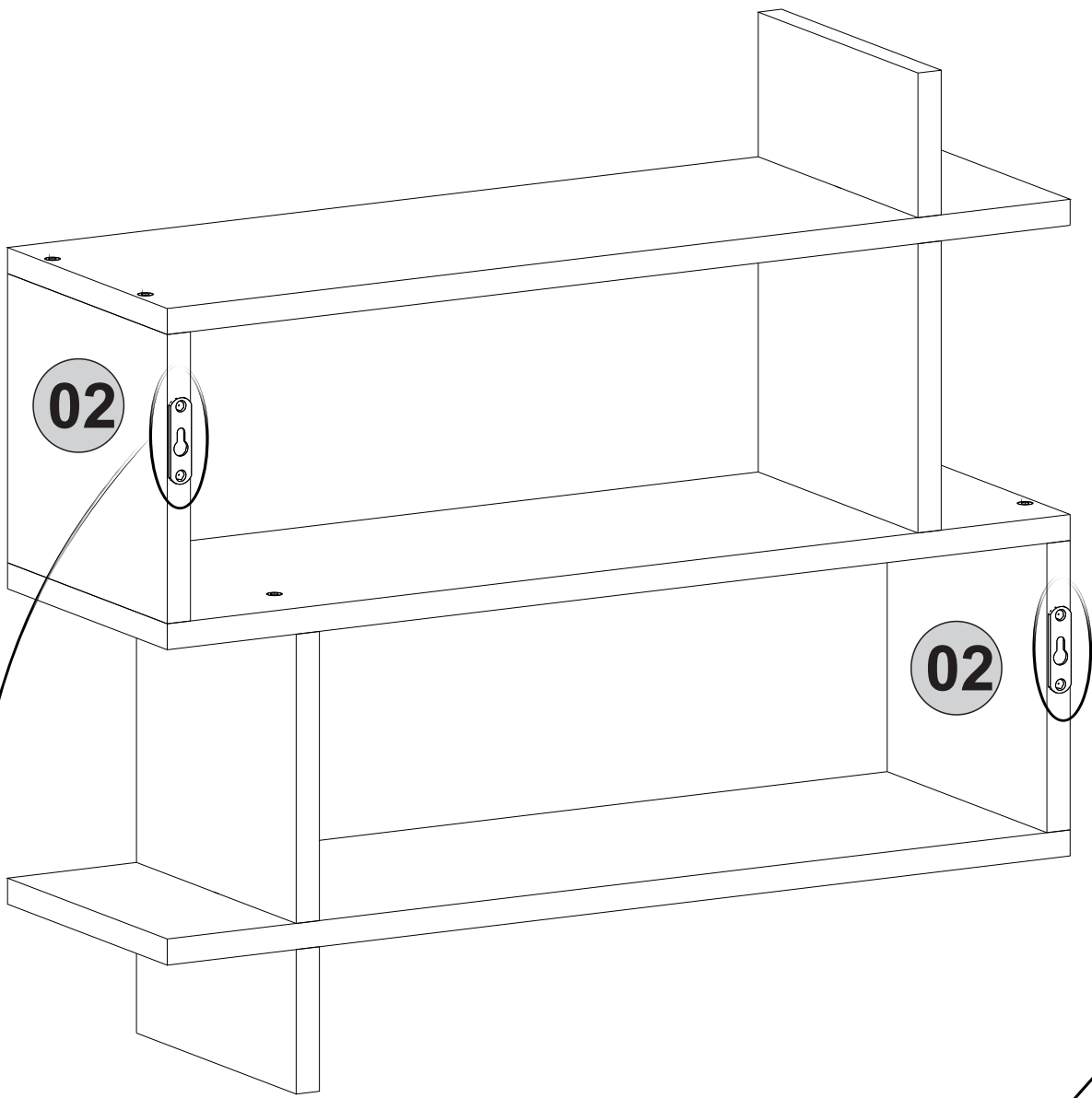

8 step

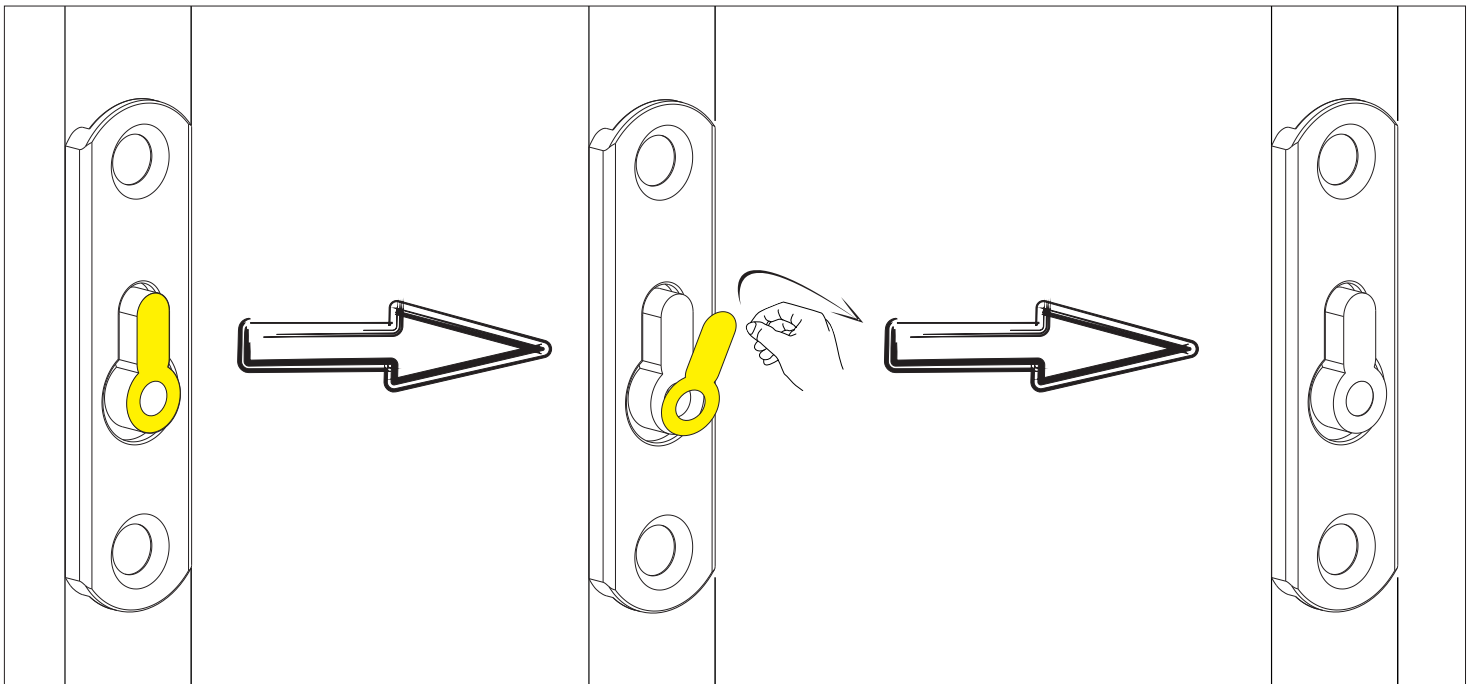
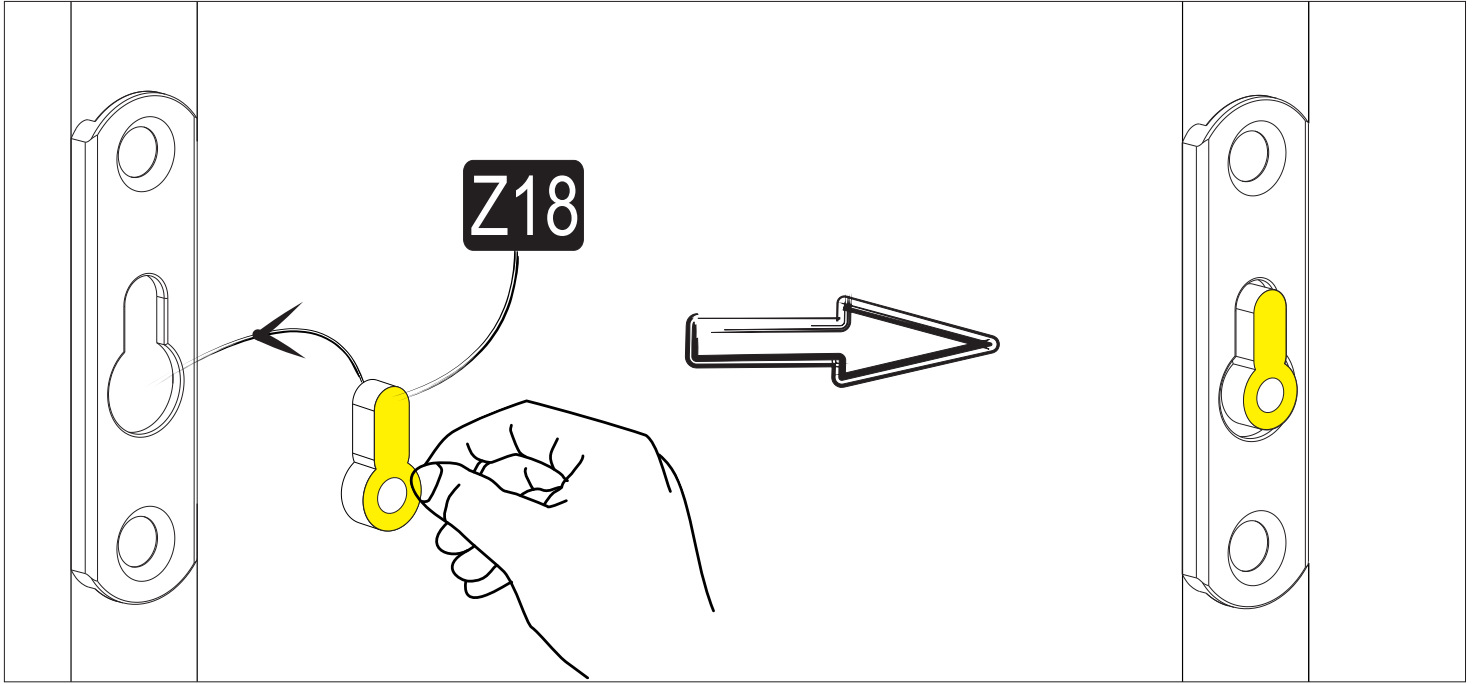

9^{step}

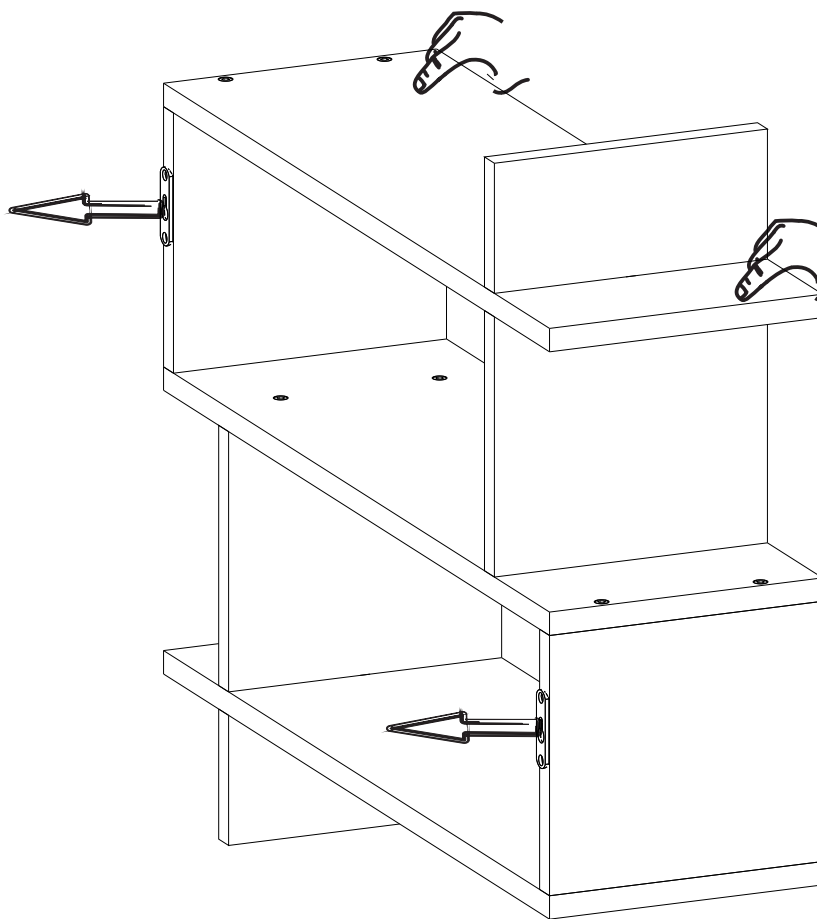
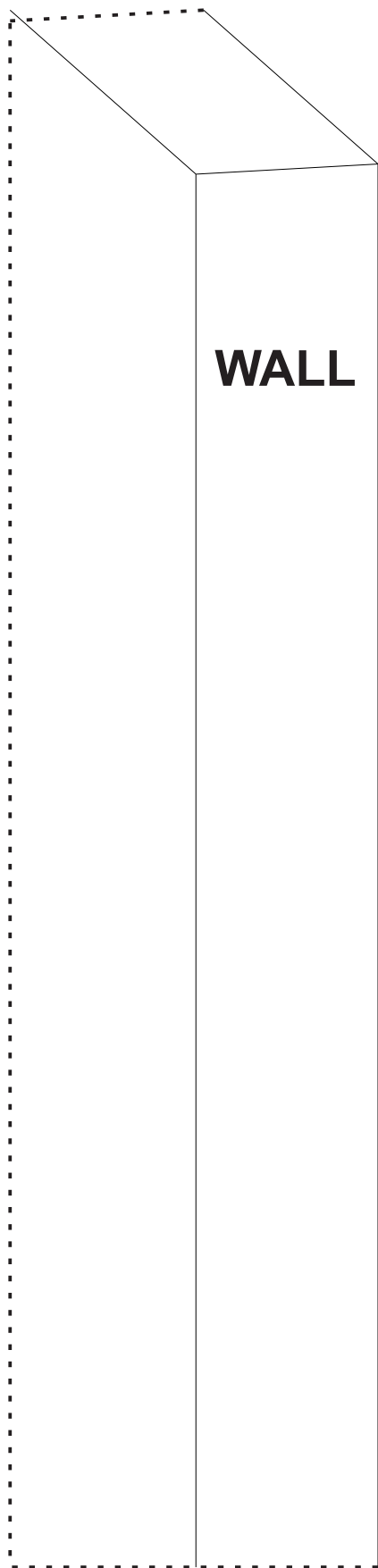

10.^{step}

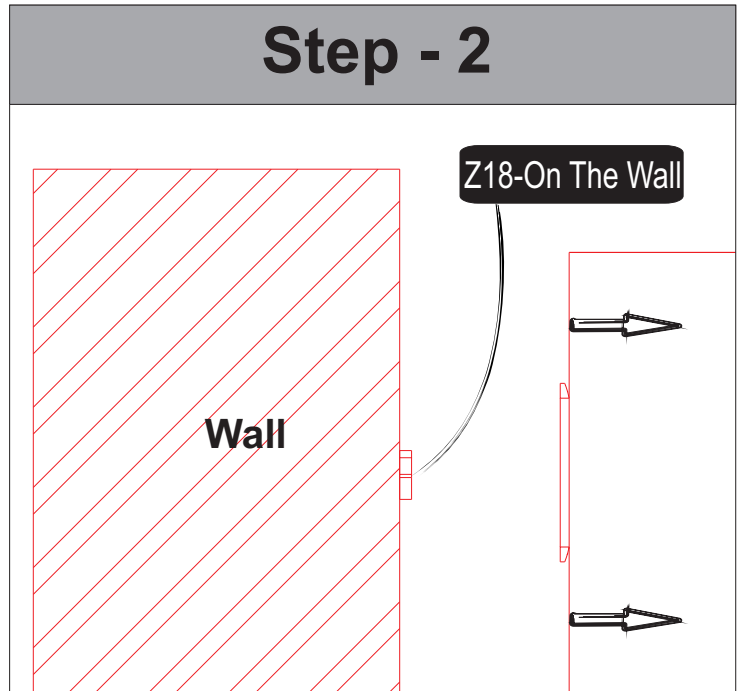
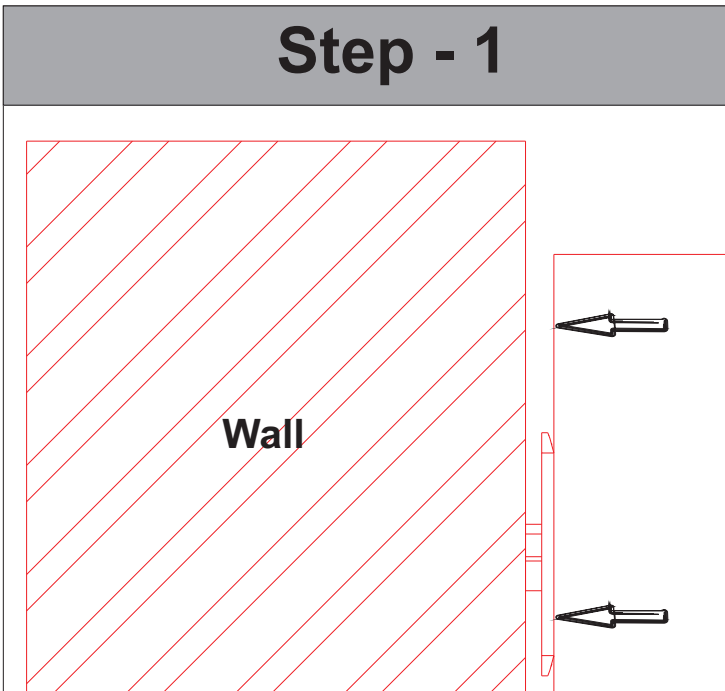
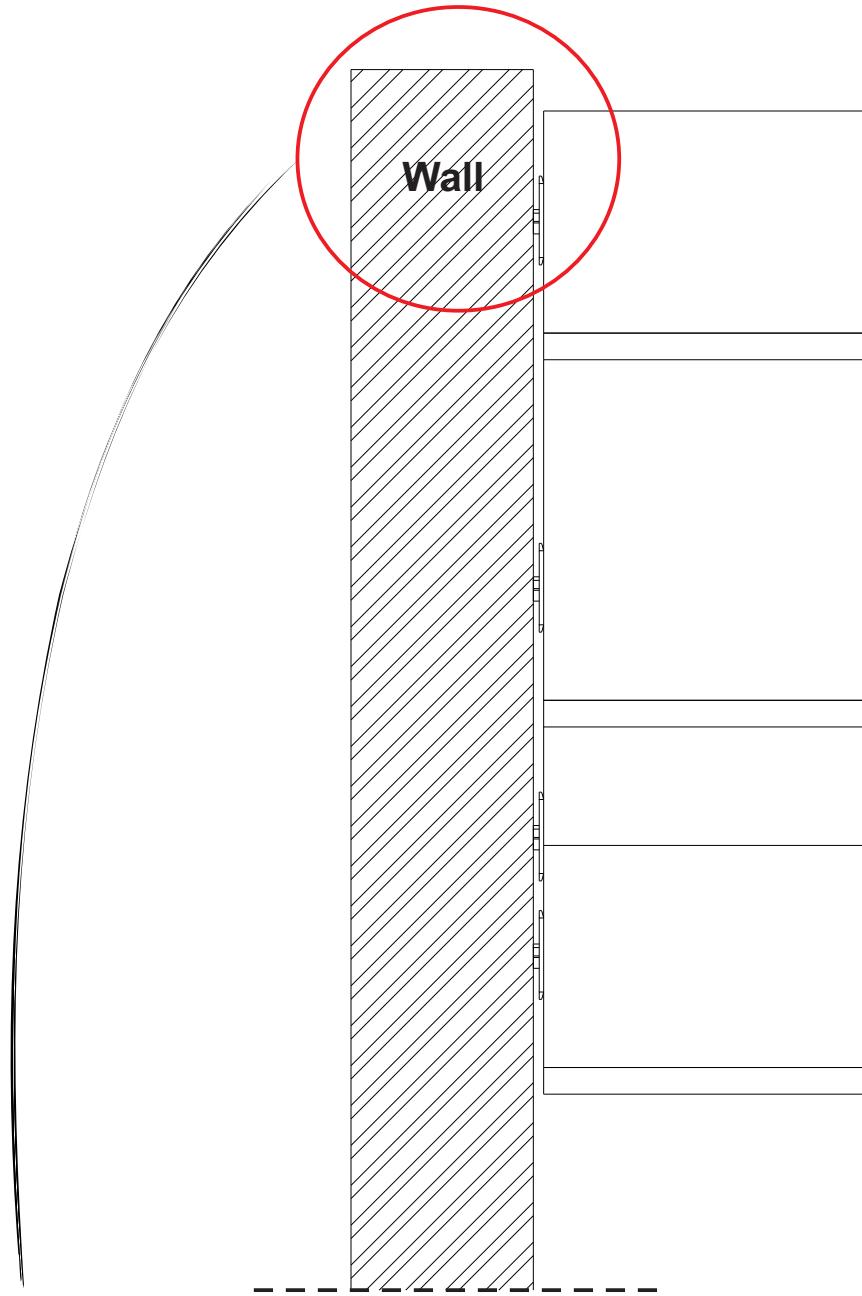

11. step

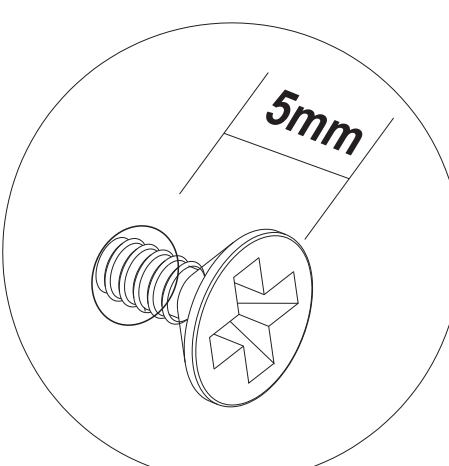
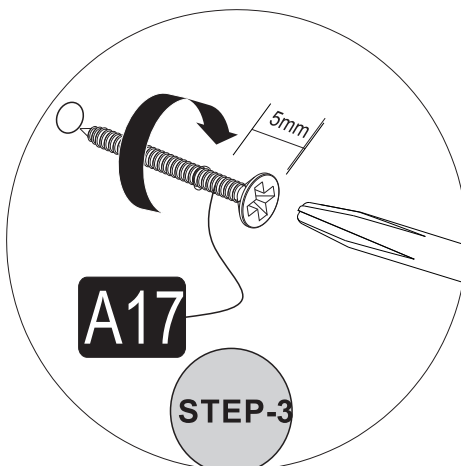
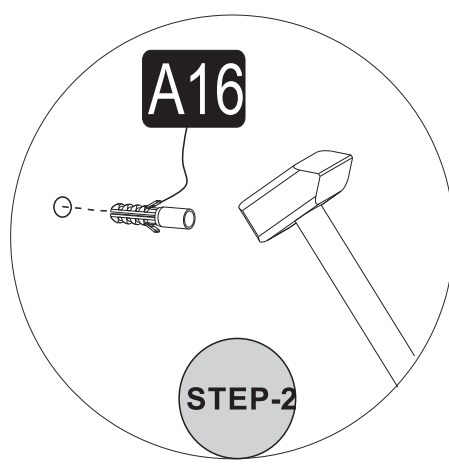
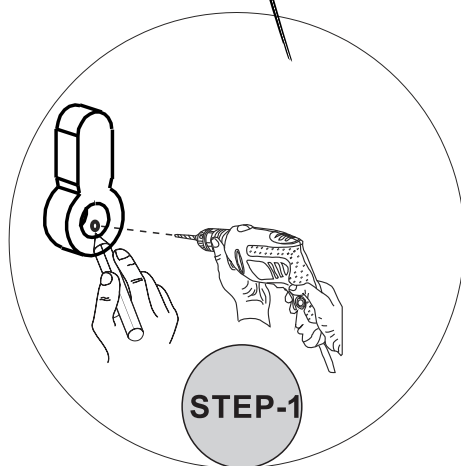
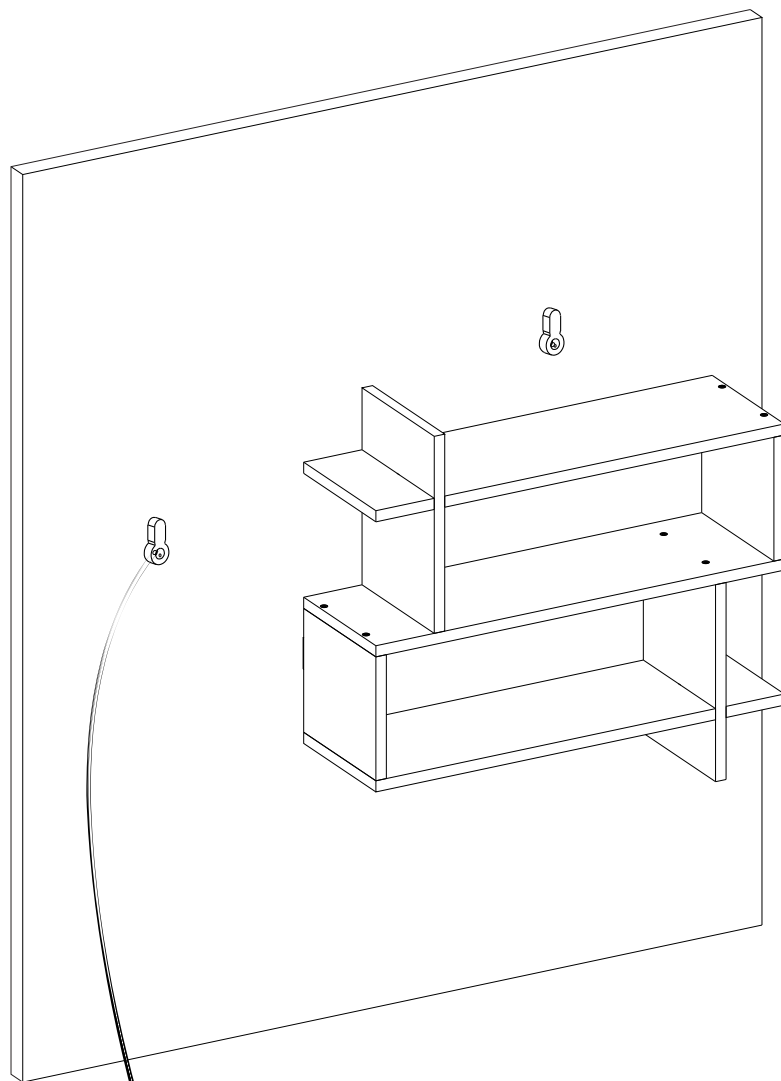

12_{step}

