

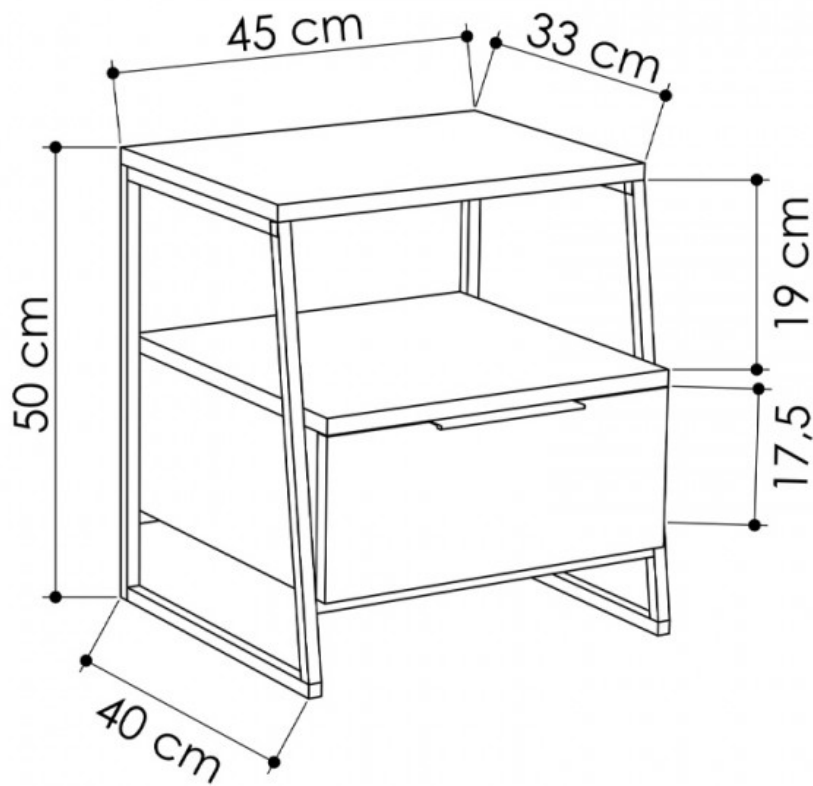









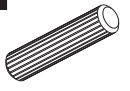

GP037-0151,3

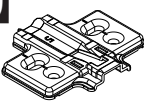
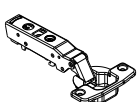
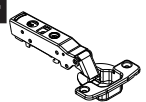

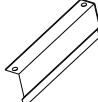
B11  10 (black)mm 4x	Z54  Pp1501 4x	A22  Minifix k18 12x	A23  Minifix M10 12x	A04  Ø8 12x
B13  25 (black)mm 8x	A12  Allen 1x	C20  Mtk(S) 2x	C17  DmF(S) 1x	C14  Dm(S) 1x
A18  3,5x18 14x	Z51  K128mm (black) 1x	A06  18mm C1-12x	A69  P.D. 8x	

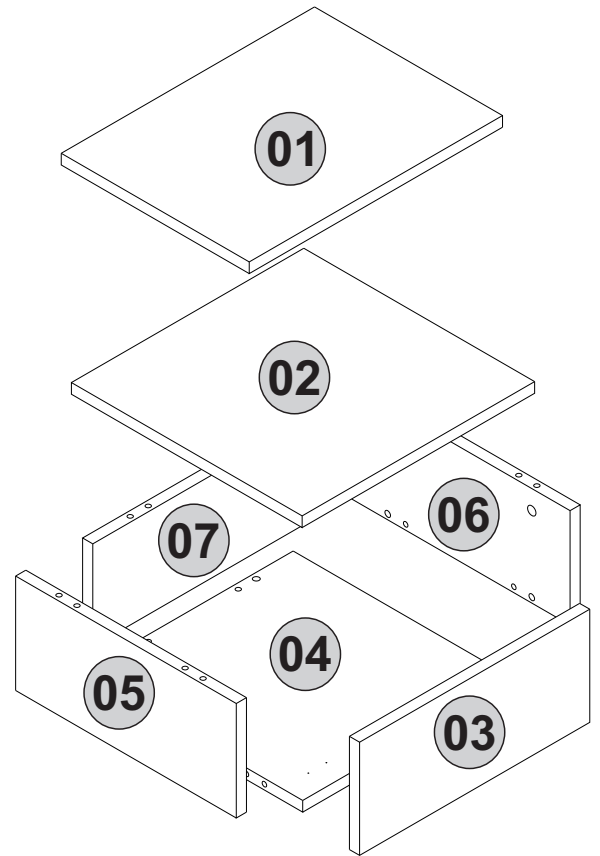
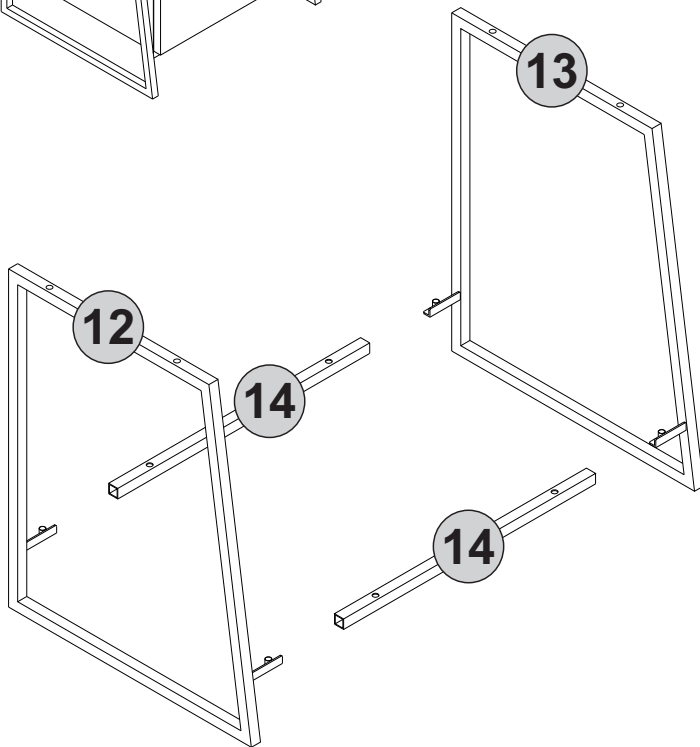
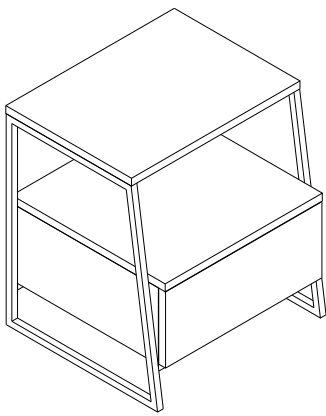

1. step

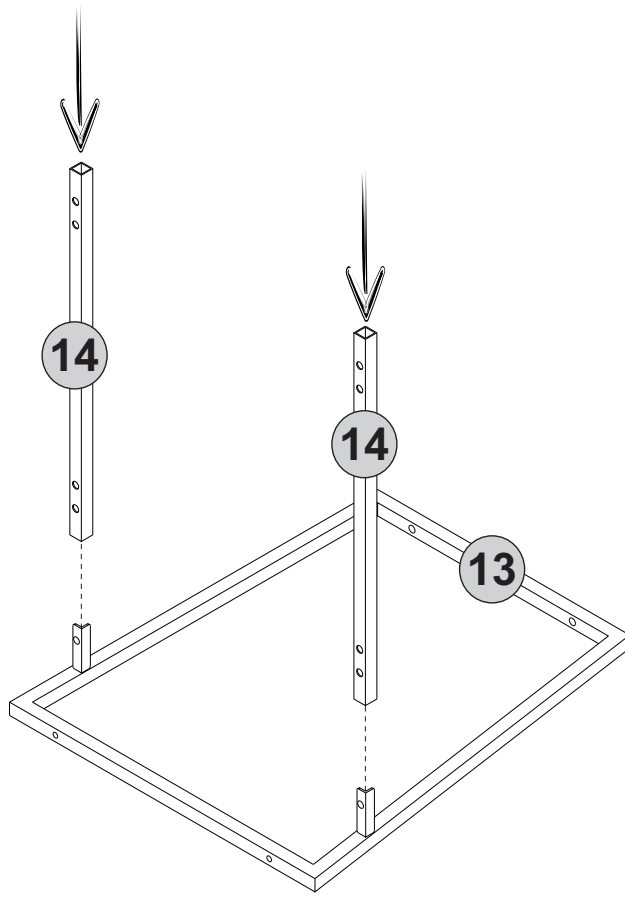

2. step

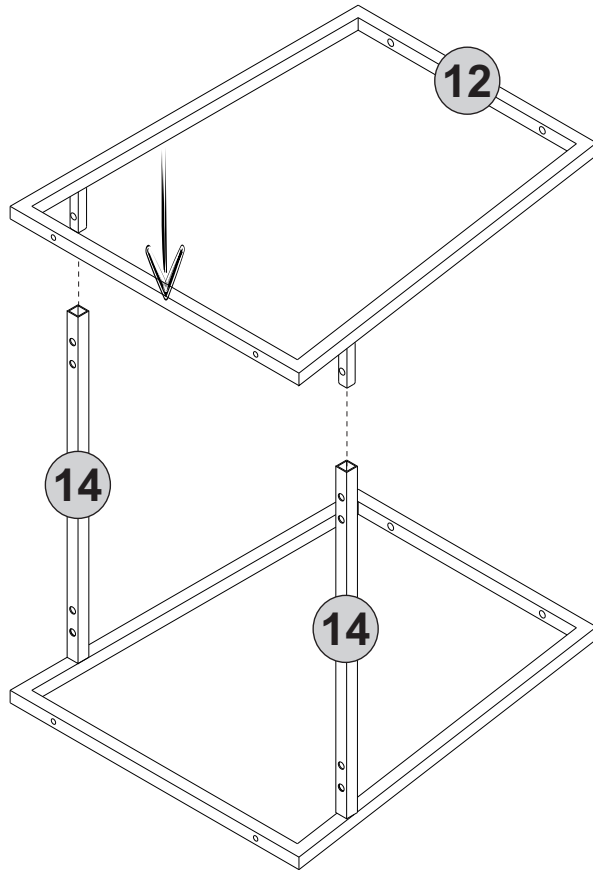

3_{step}

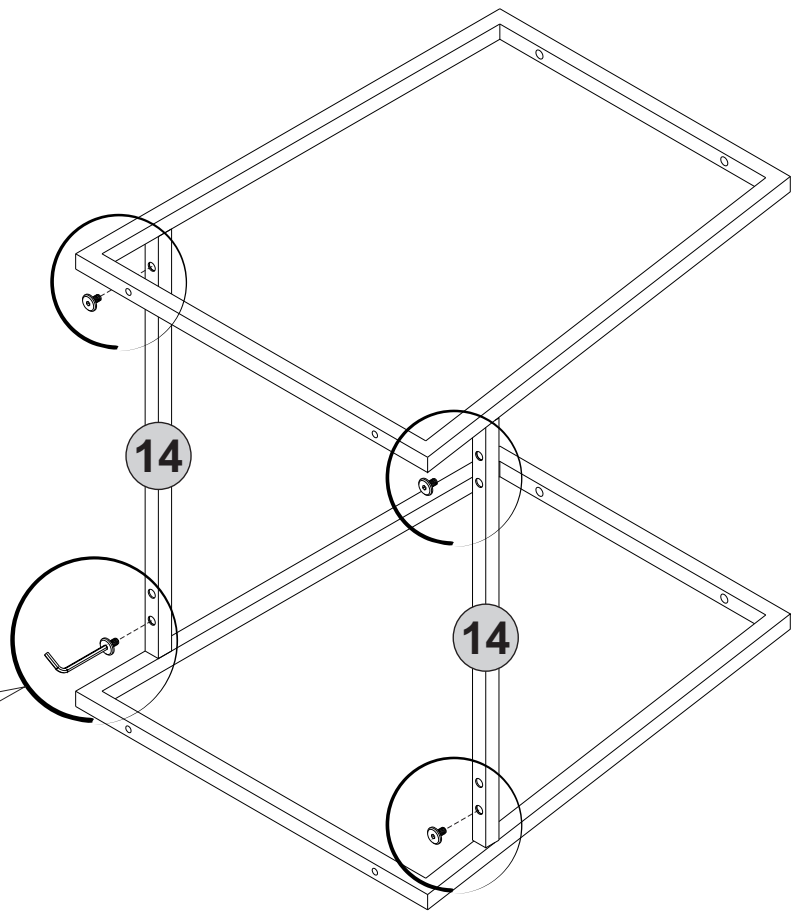
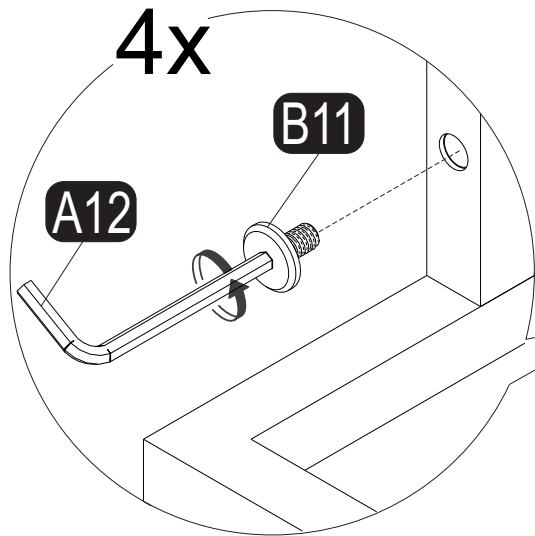
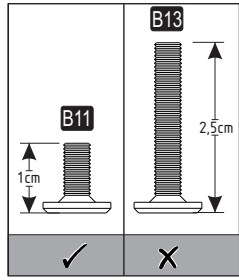

4_{step}

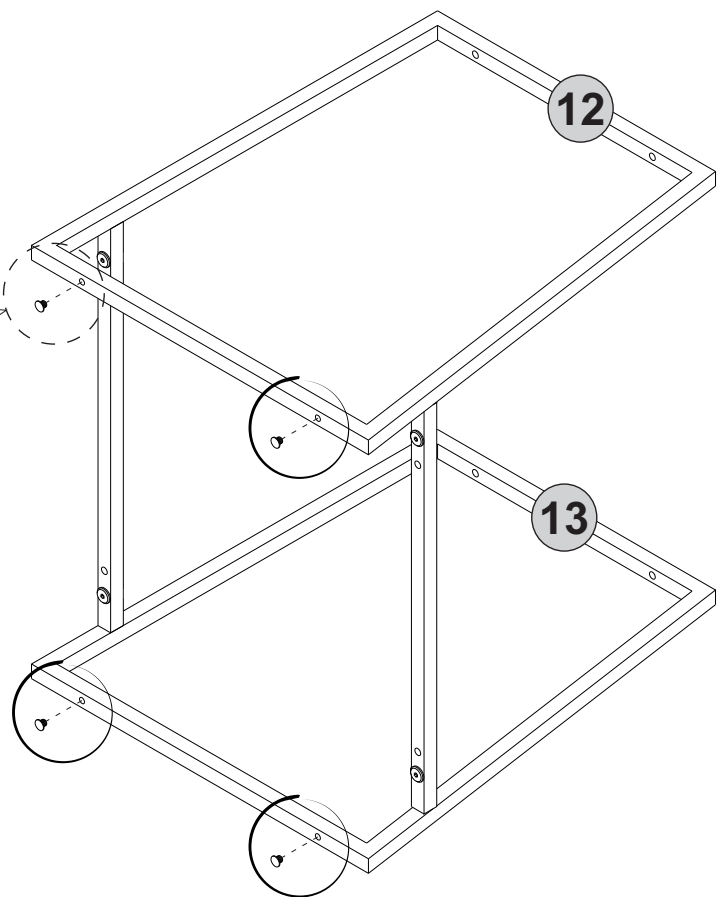
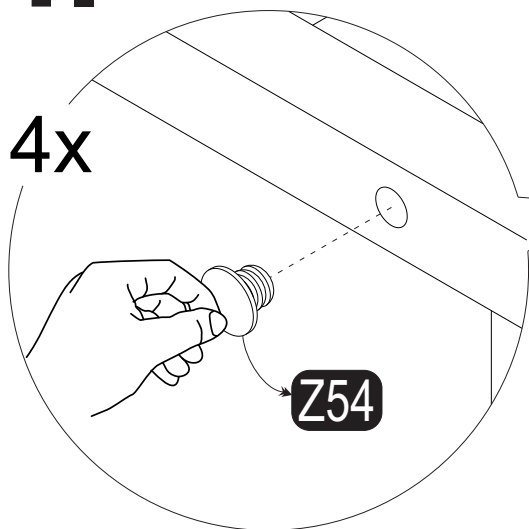

5^{step}

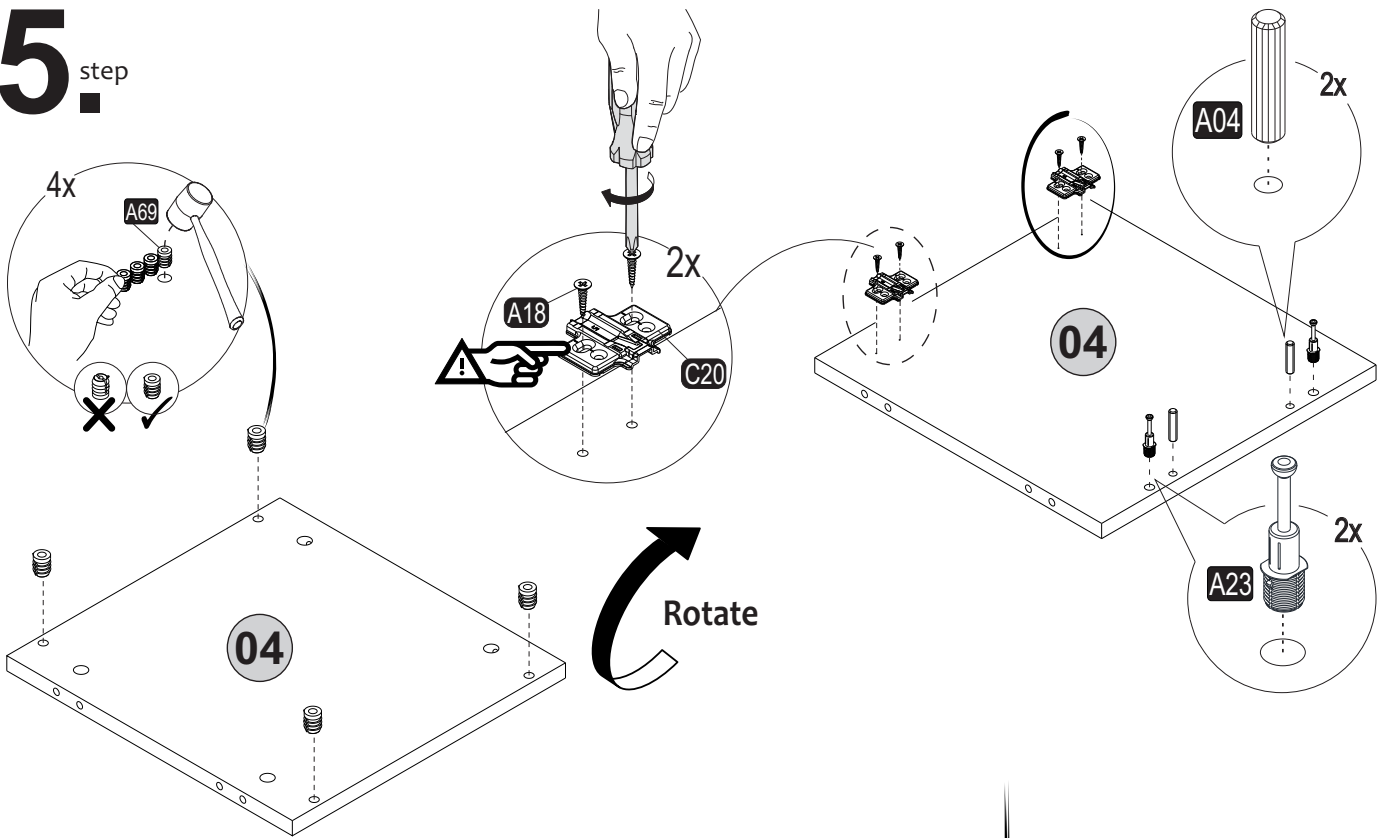

6^{step}

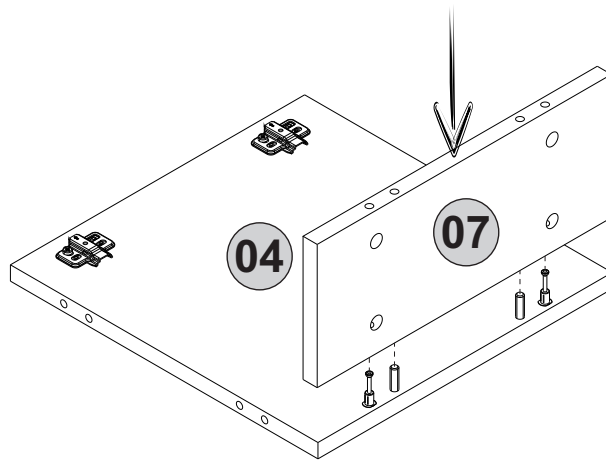

7^{step}

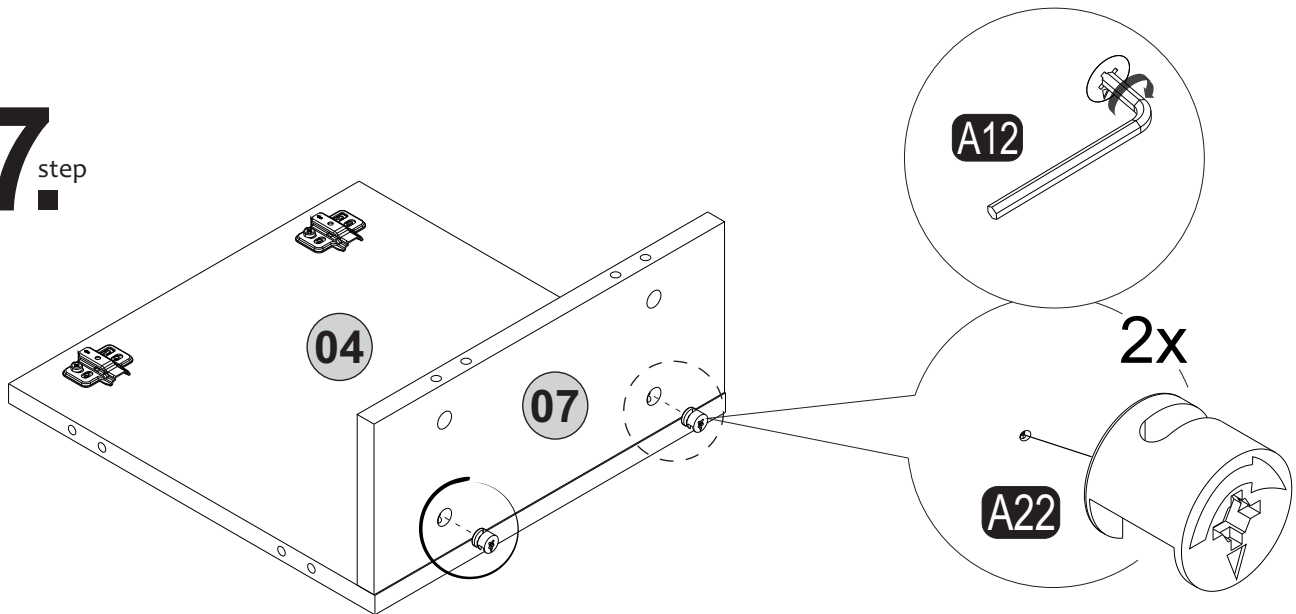

8^{step}

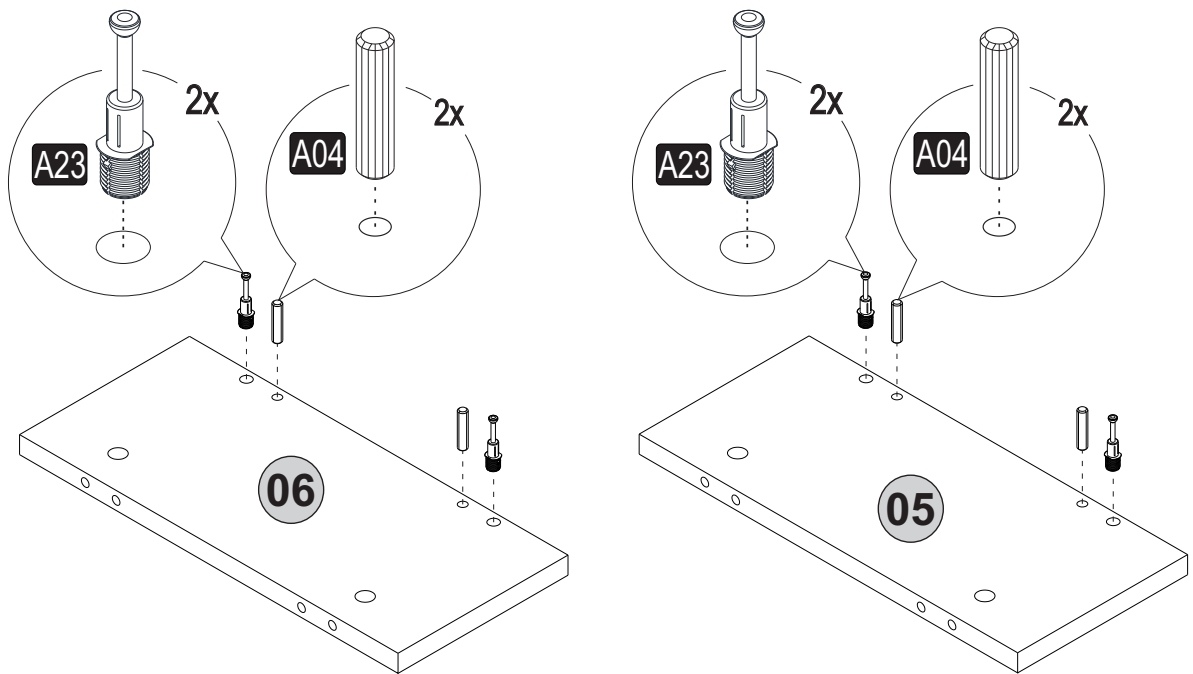

9^{step}

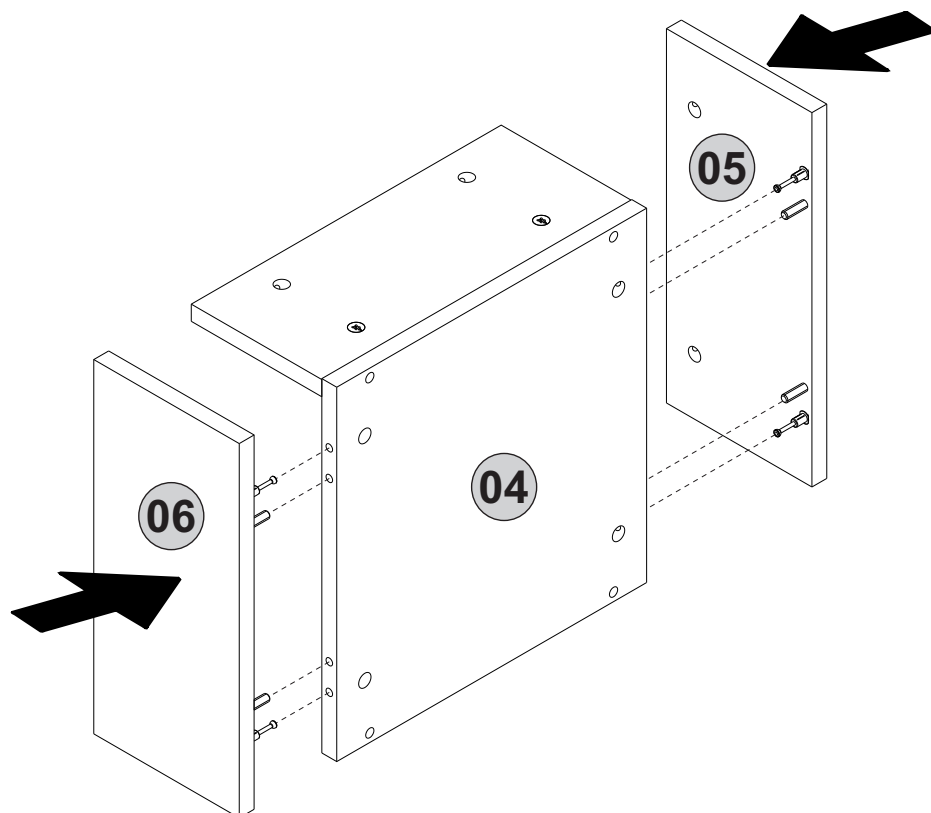

10._{step}

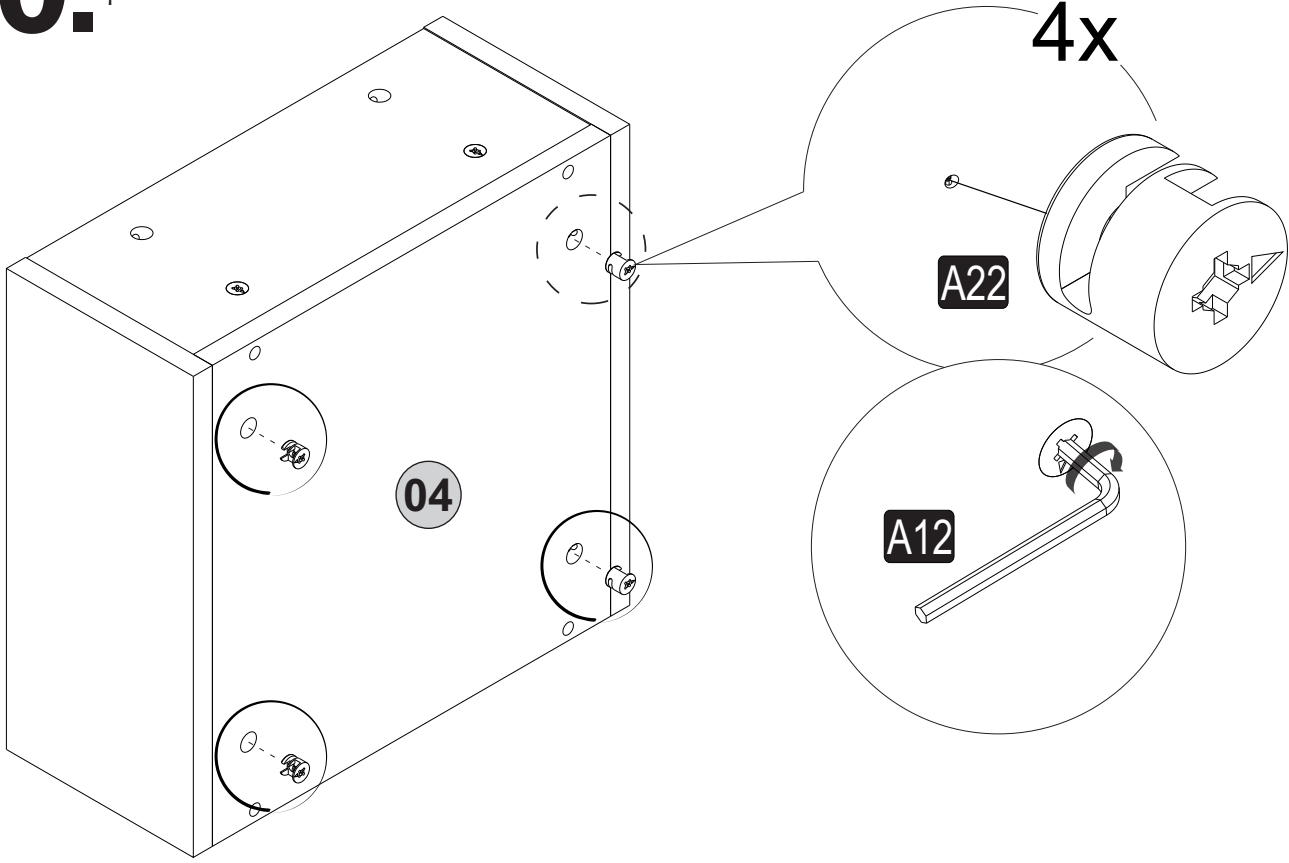

11._{step}

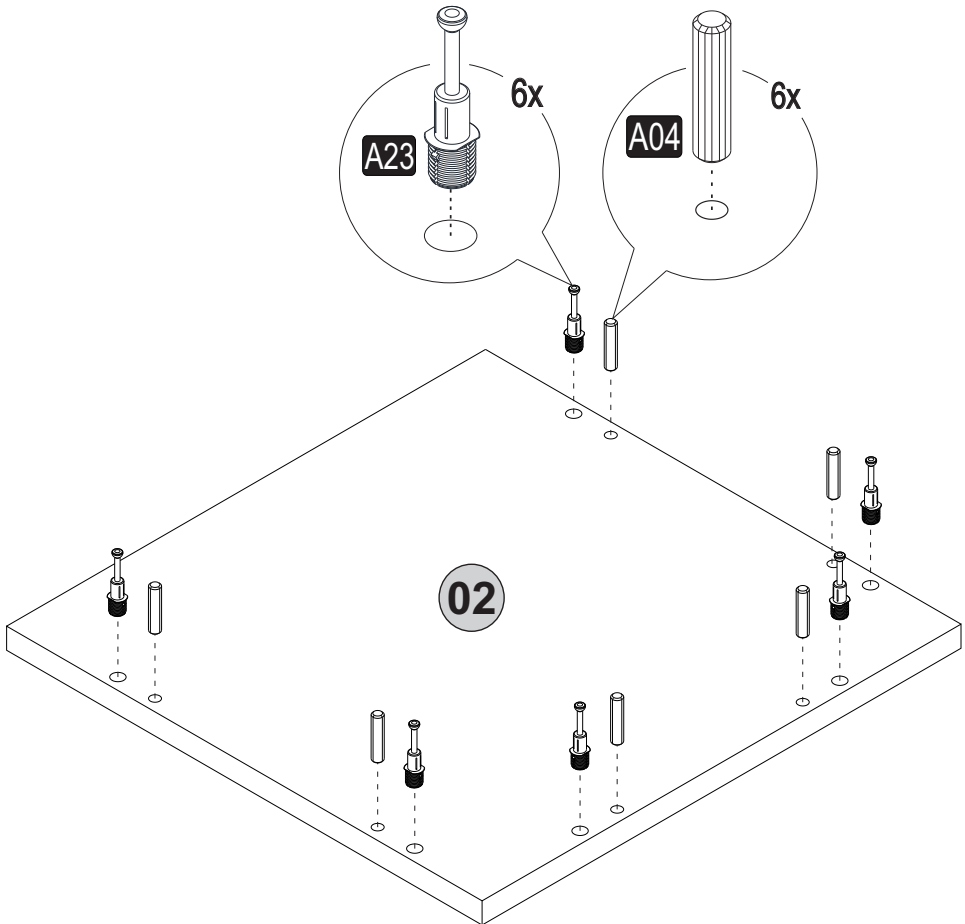

12.^{step}

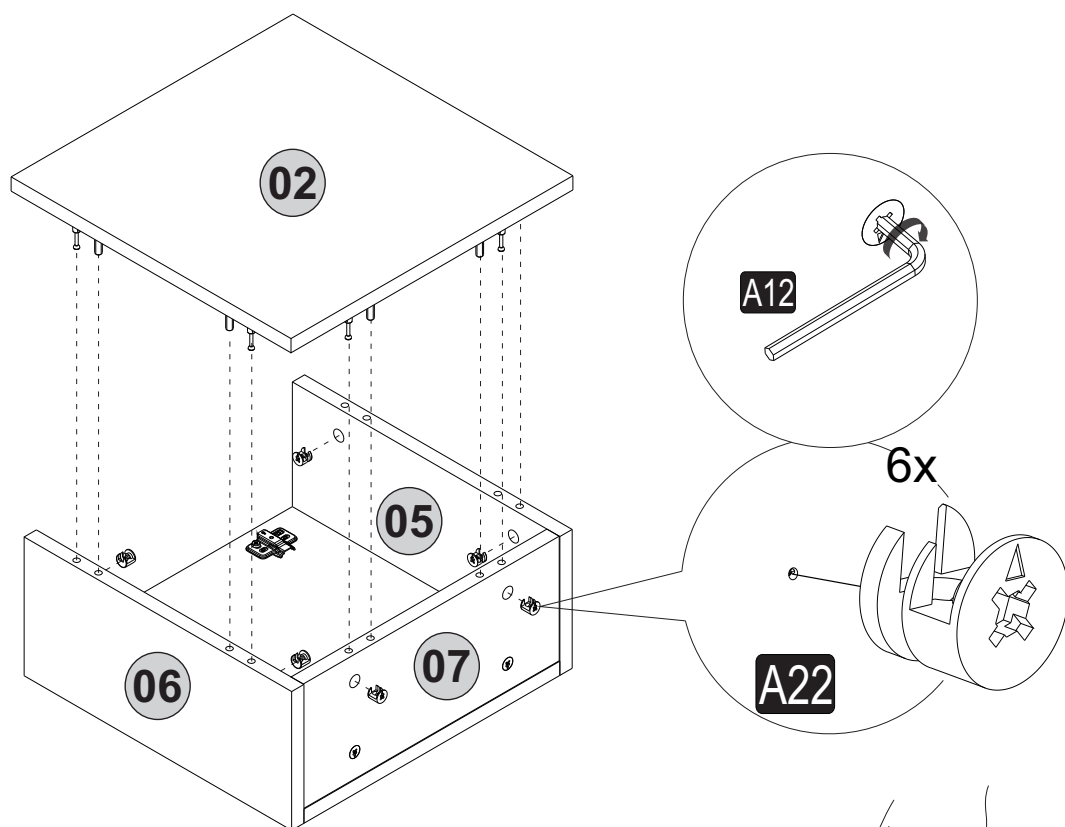

13.^{step}

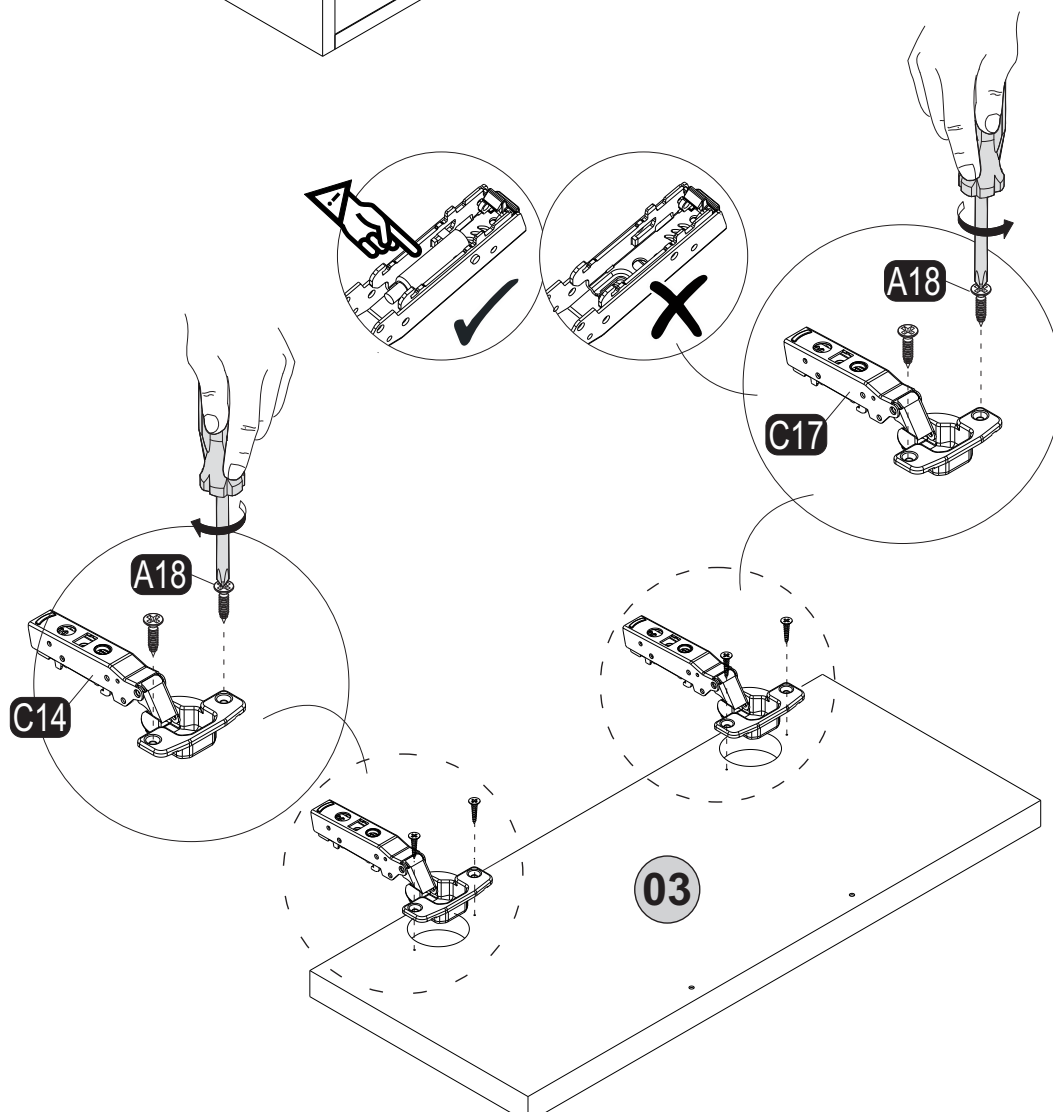

14.^{step}

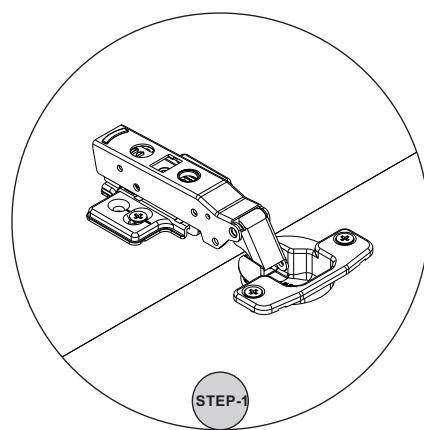
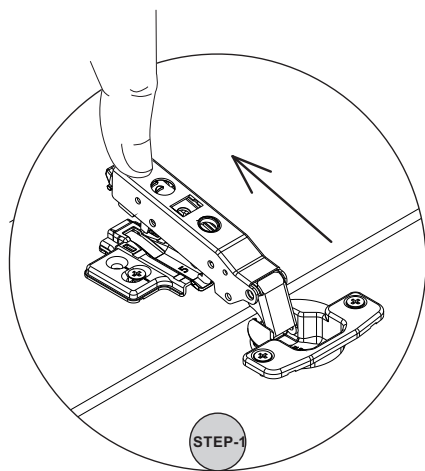
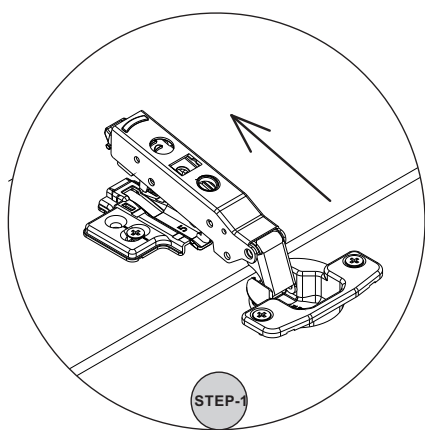
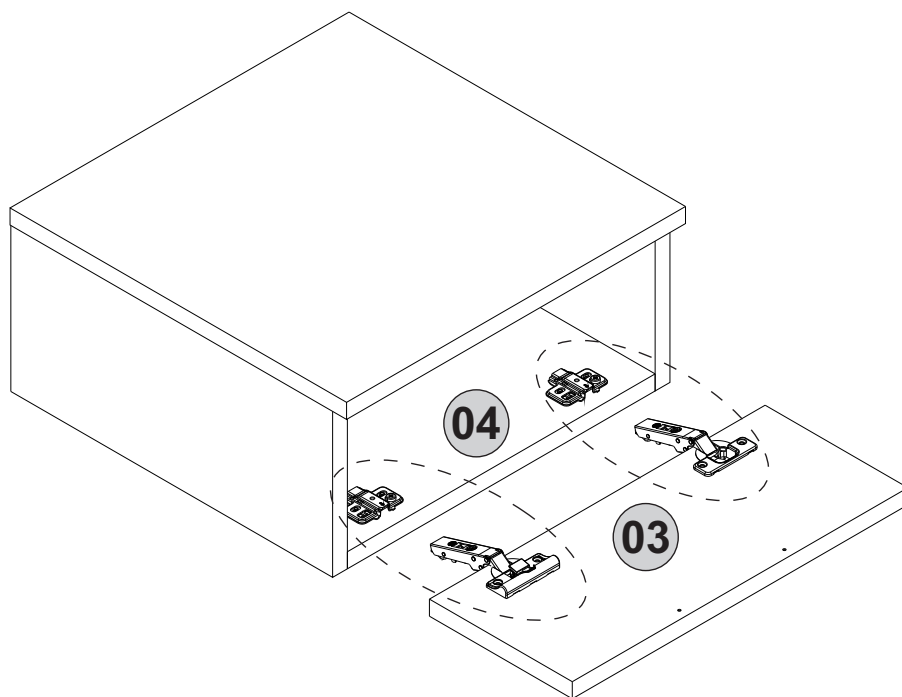

15.^{step}

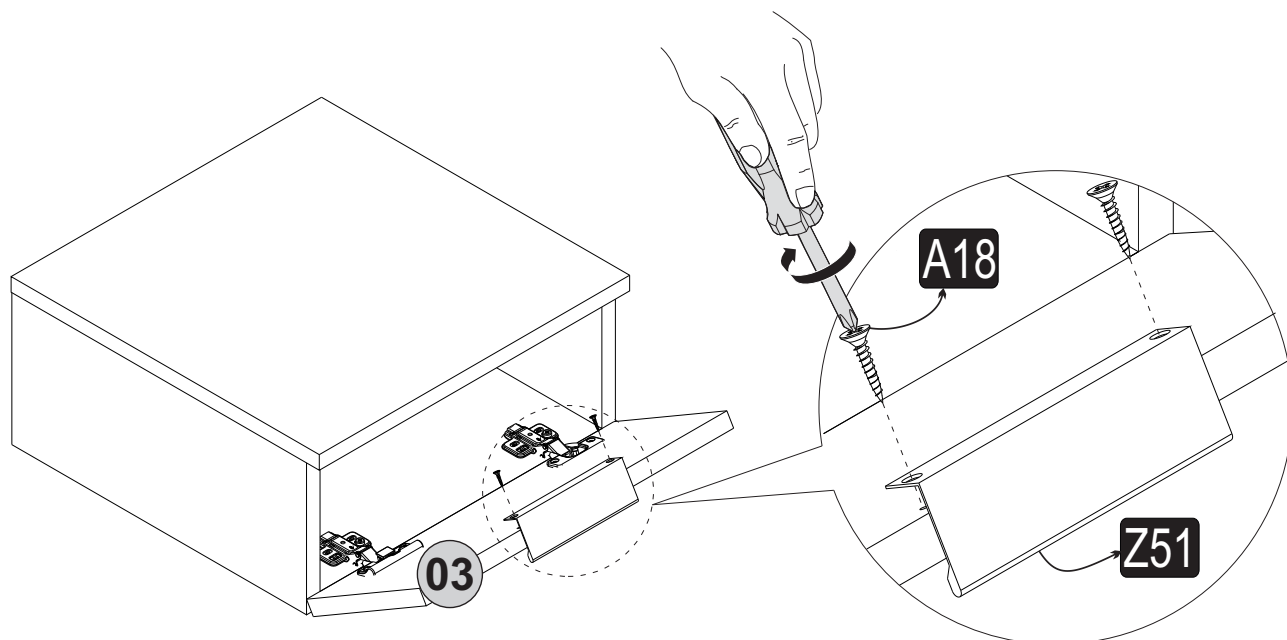

16.^{step}

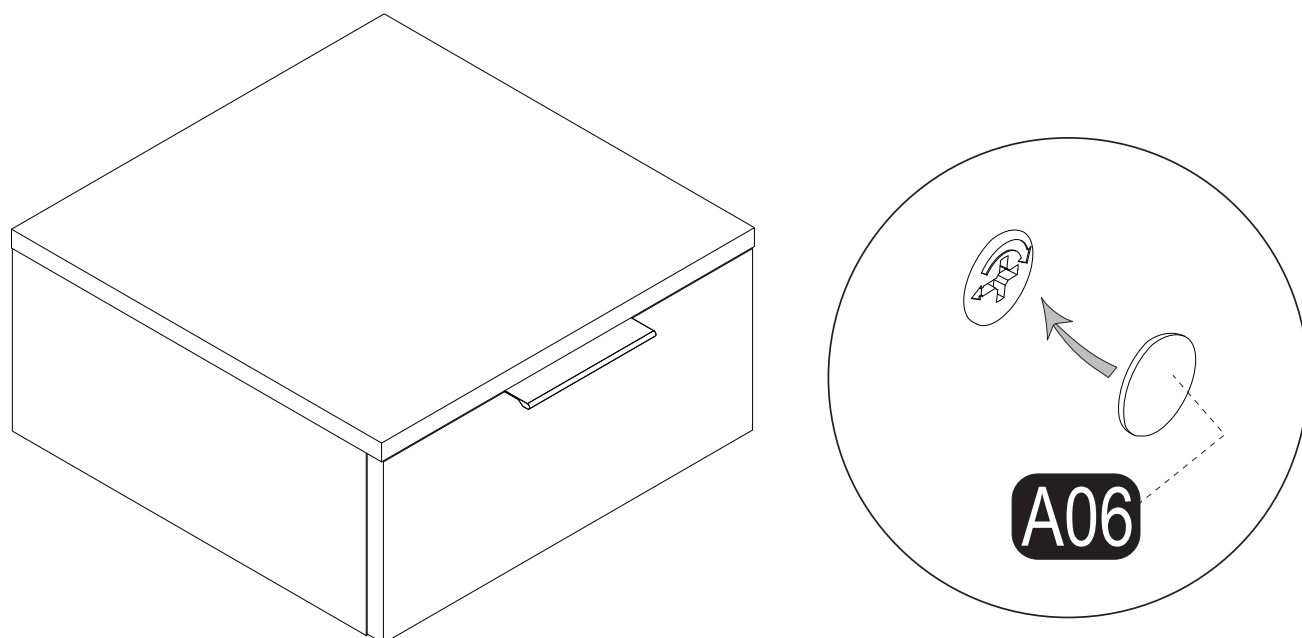

17.^{step}

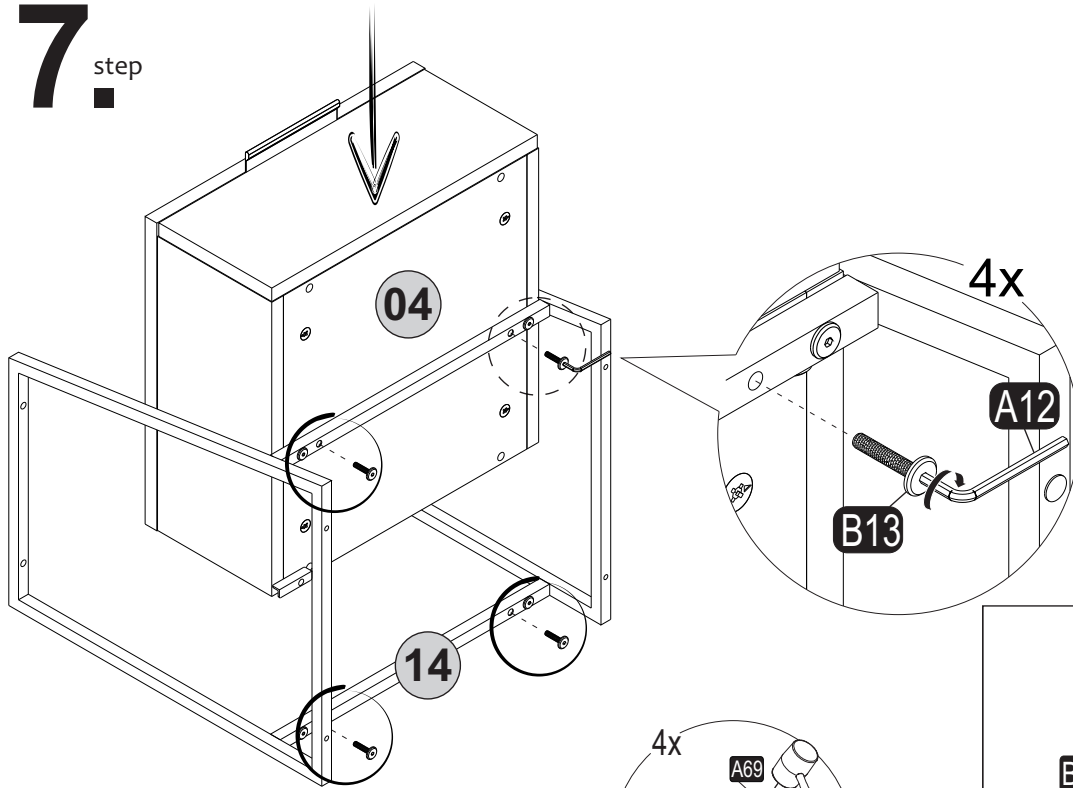

18.^{step}

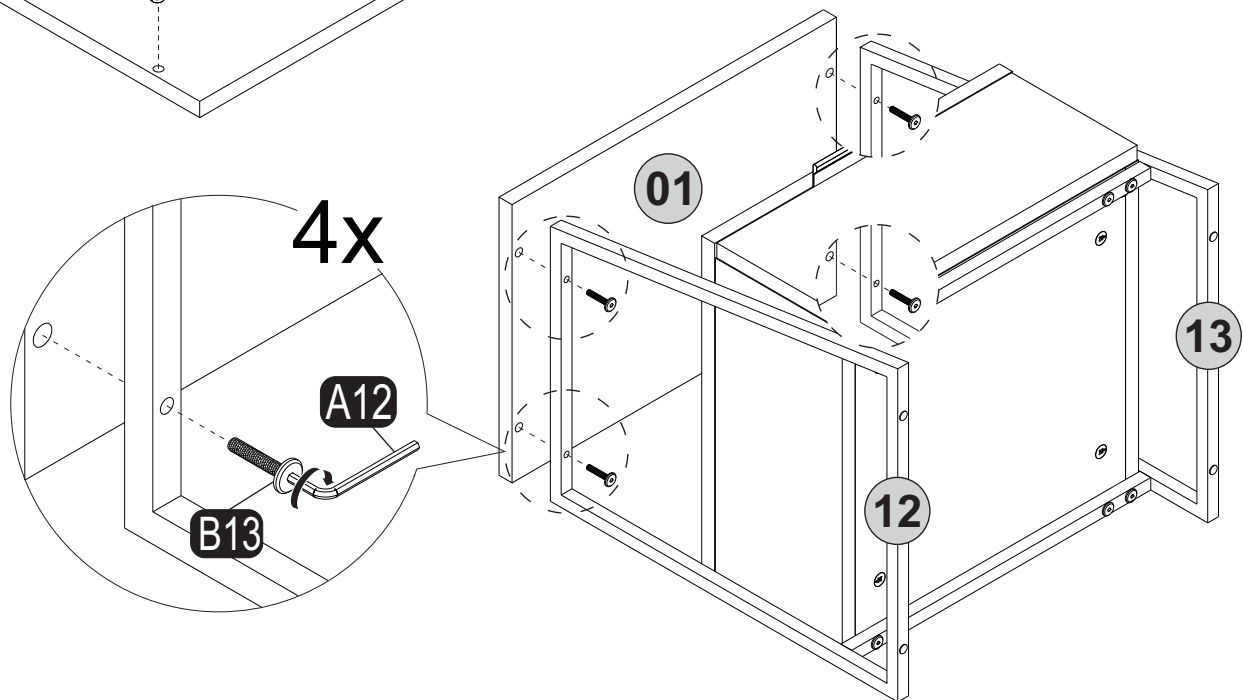
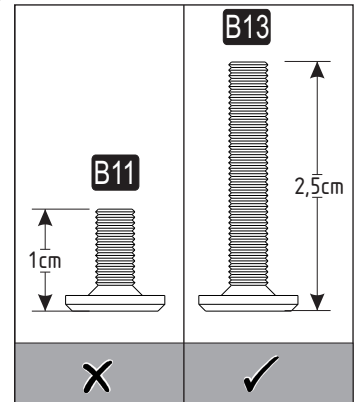
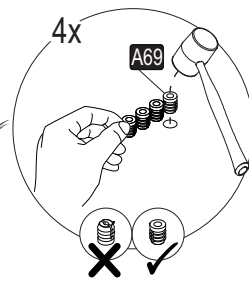
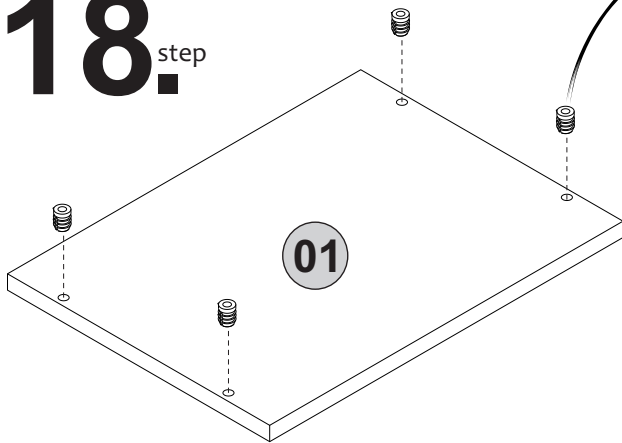

19_{step}

