

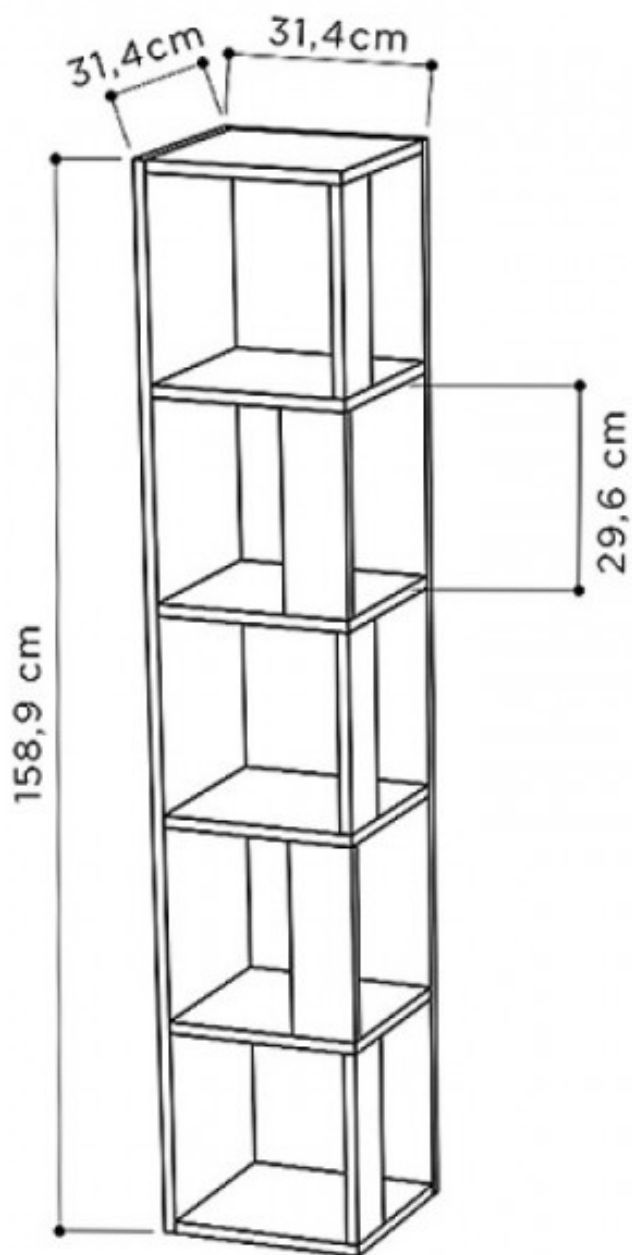

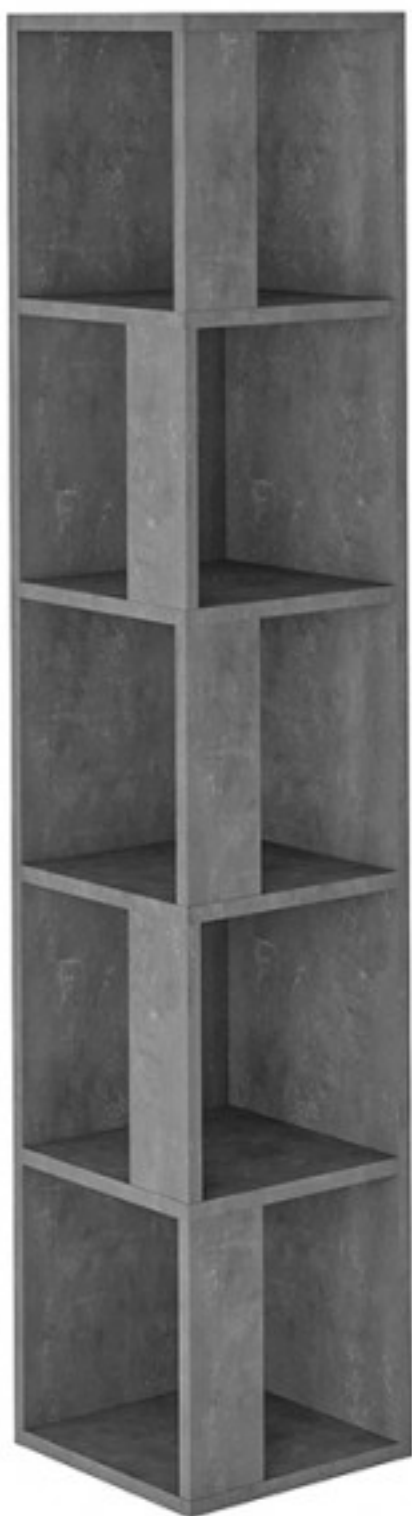

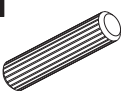



**i** GP037-0155,5

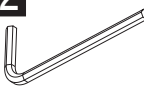

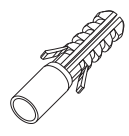
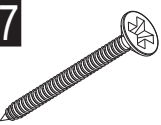
<b>A04</b>  Ø8 20x	<b>A06</b>  18mm 41x	<b>A12</b>  4 sw 1x	<b>A13</b>  50mm 27x	<b>A16</b>  DbØ8 1x
<b>A17</b>  4x50 1x	<b>A18</b>  3,5x18 2x	<b>A22</b>  Minifix k18 14x	<b>A23</b>  Minifix M10 14x	<b>A26</b>  Allen 1x
<b>A41</b>  Ø8x55 4x	<b>A87</b>  15x90x30 1x	<b>PB01</b>  Kece 4x		

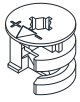

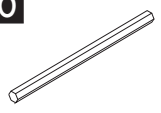
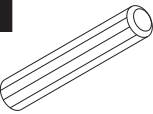
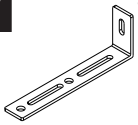
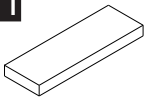
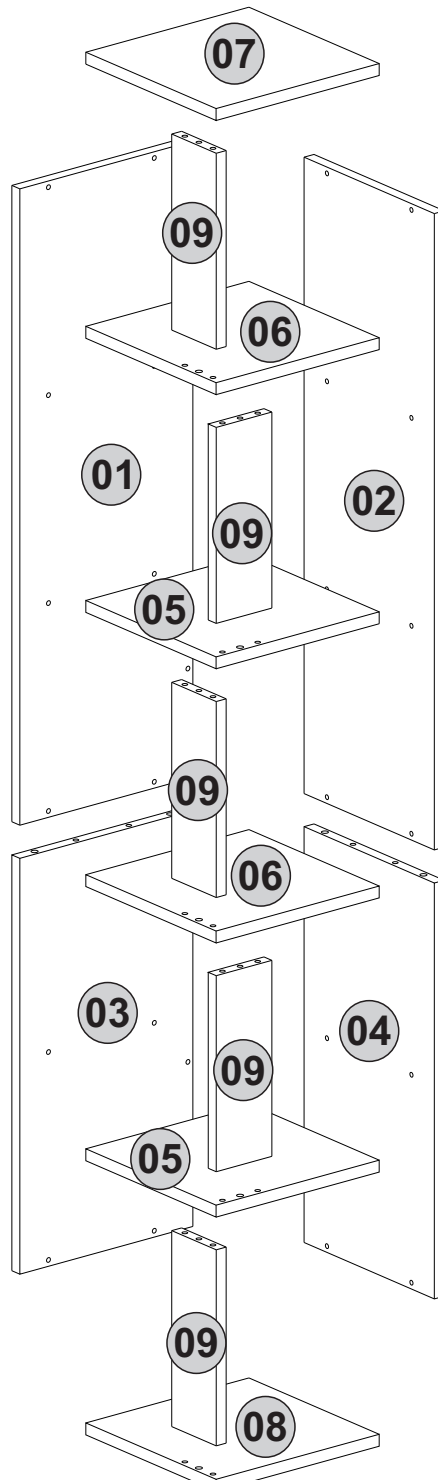
1

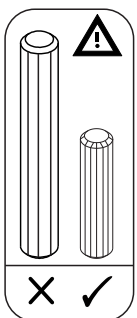
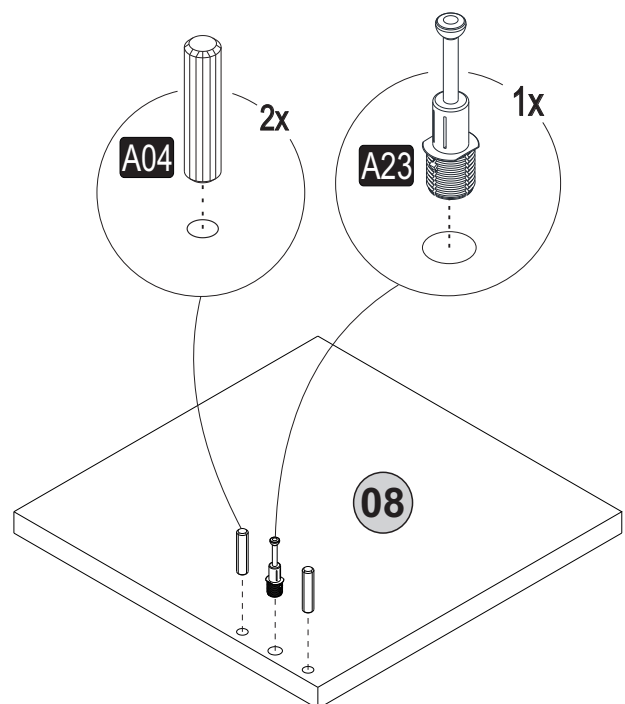
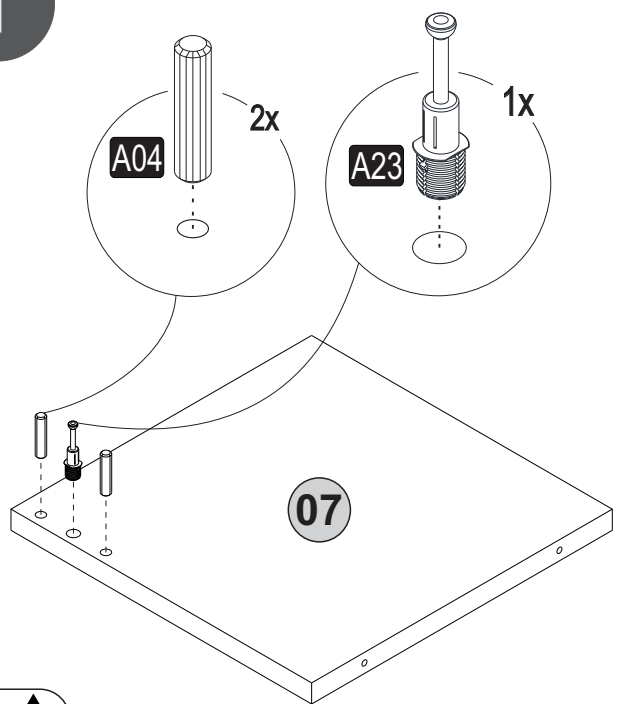

2

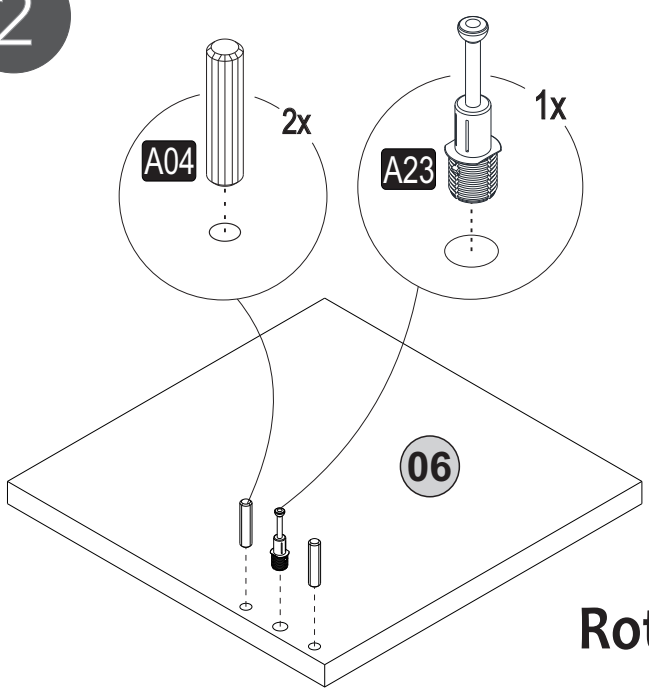

Rotate

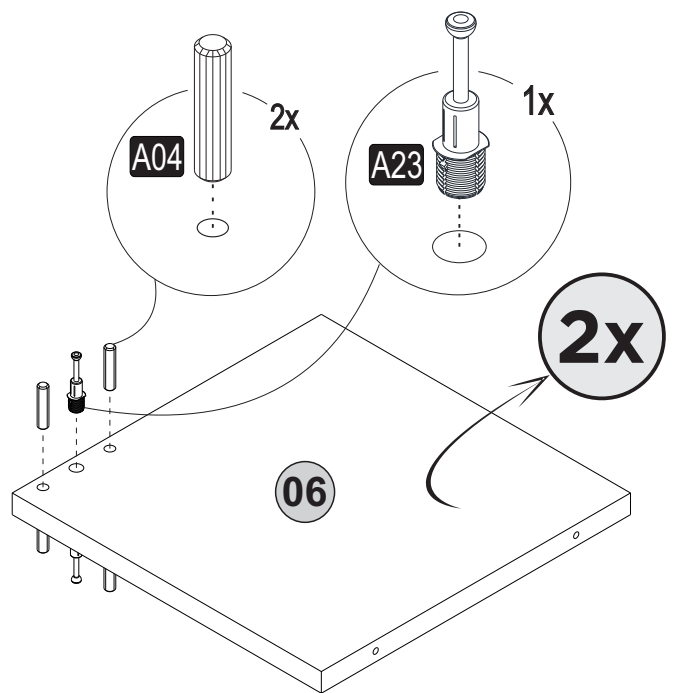

3

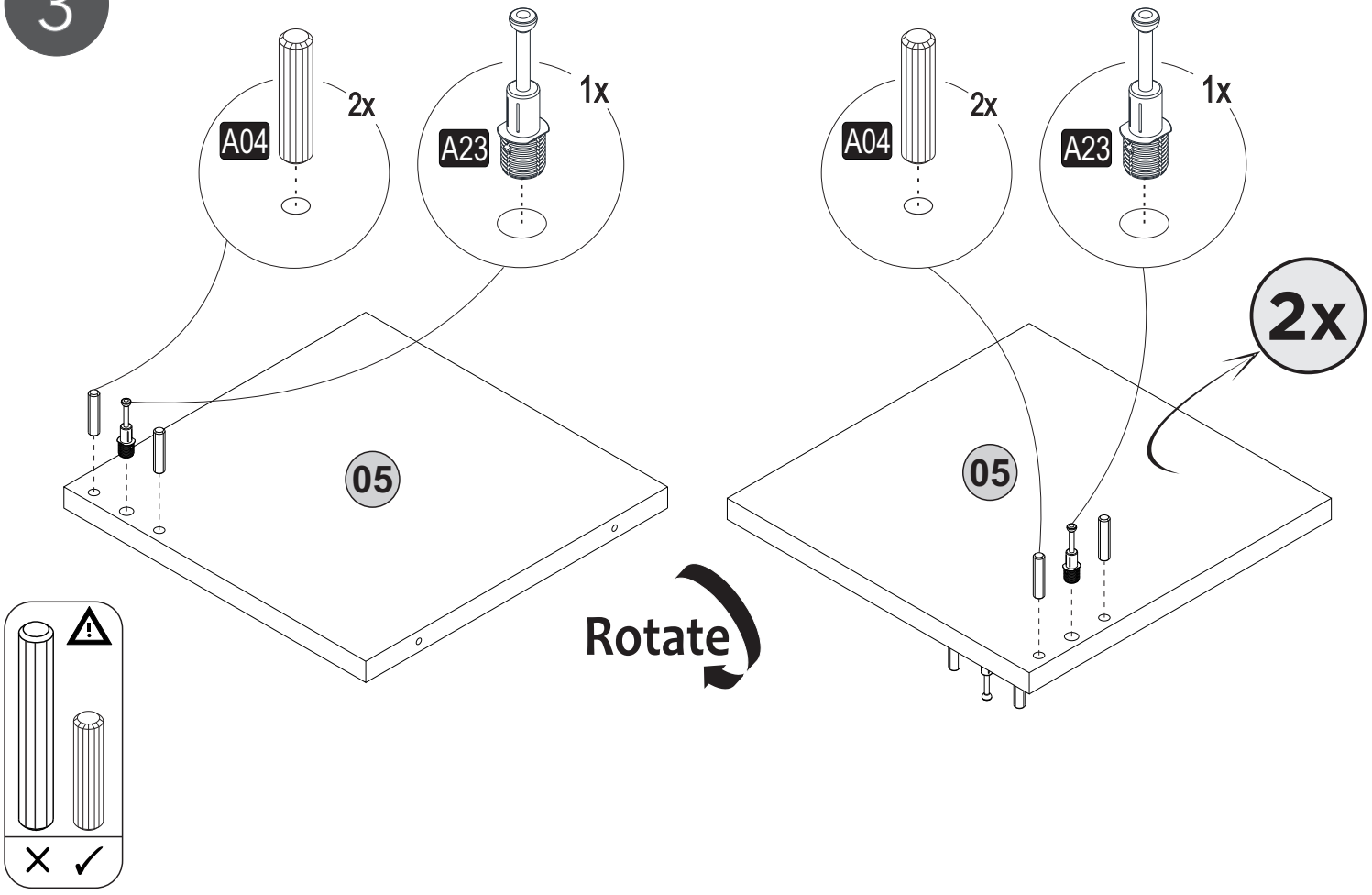

4

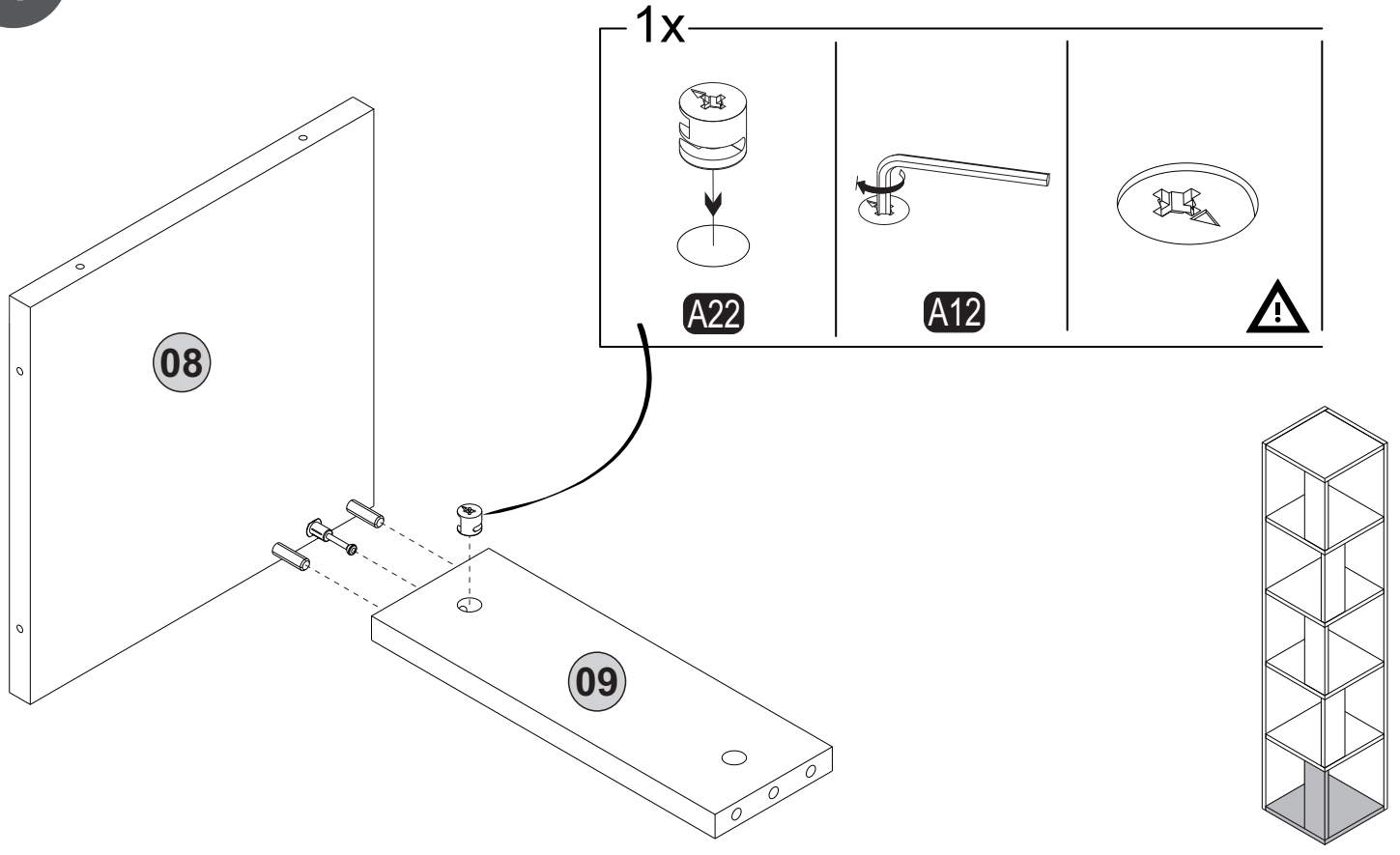

5

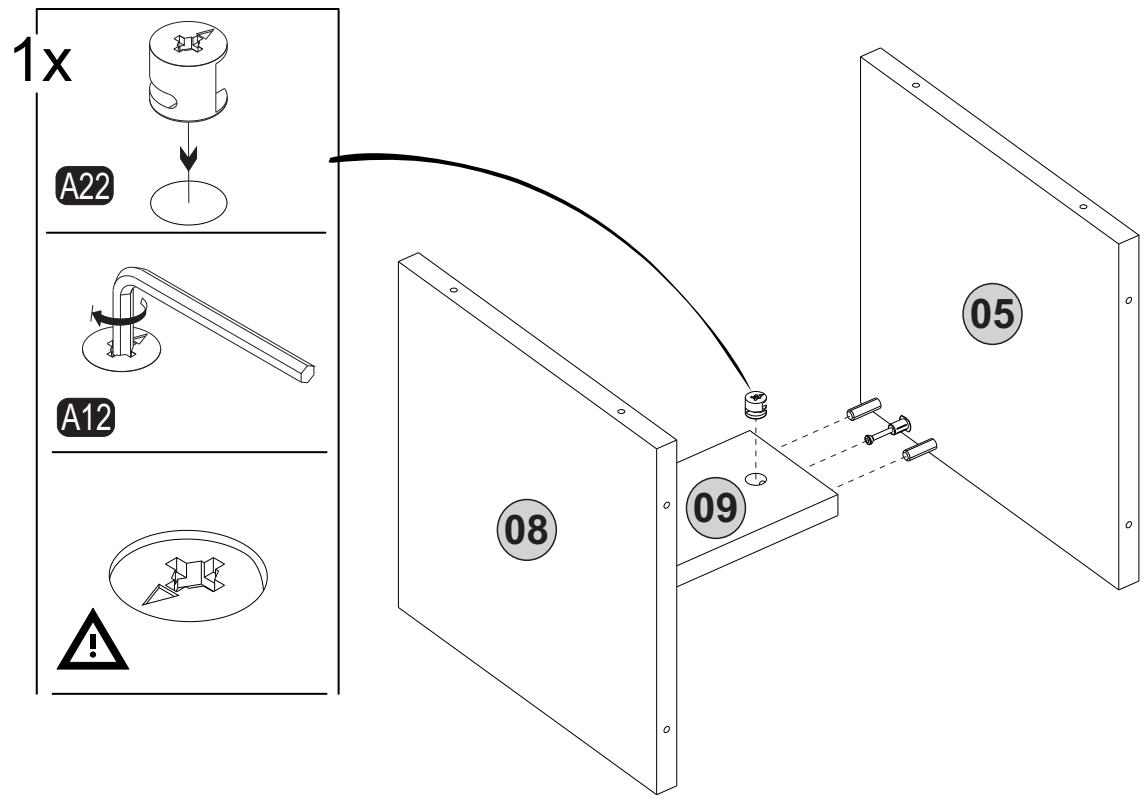

6

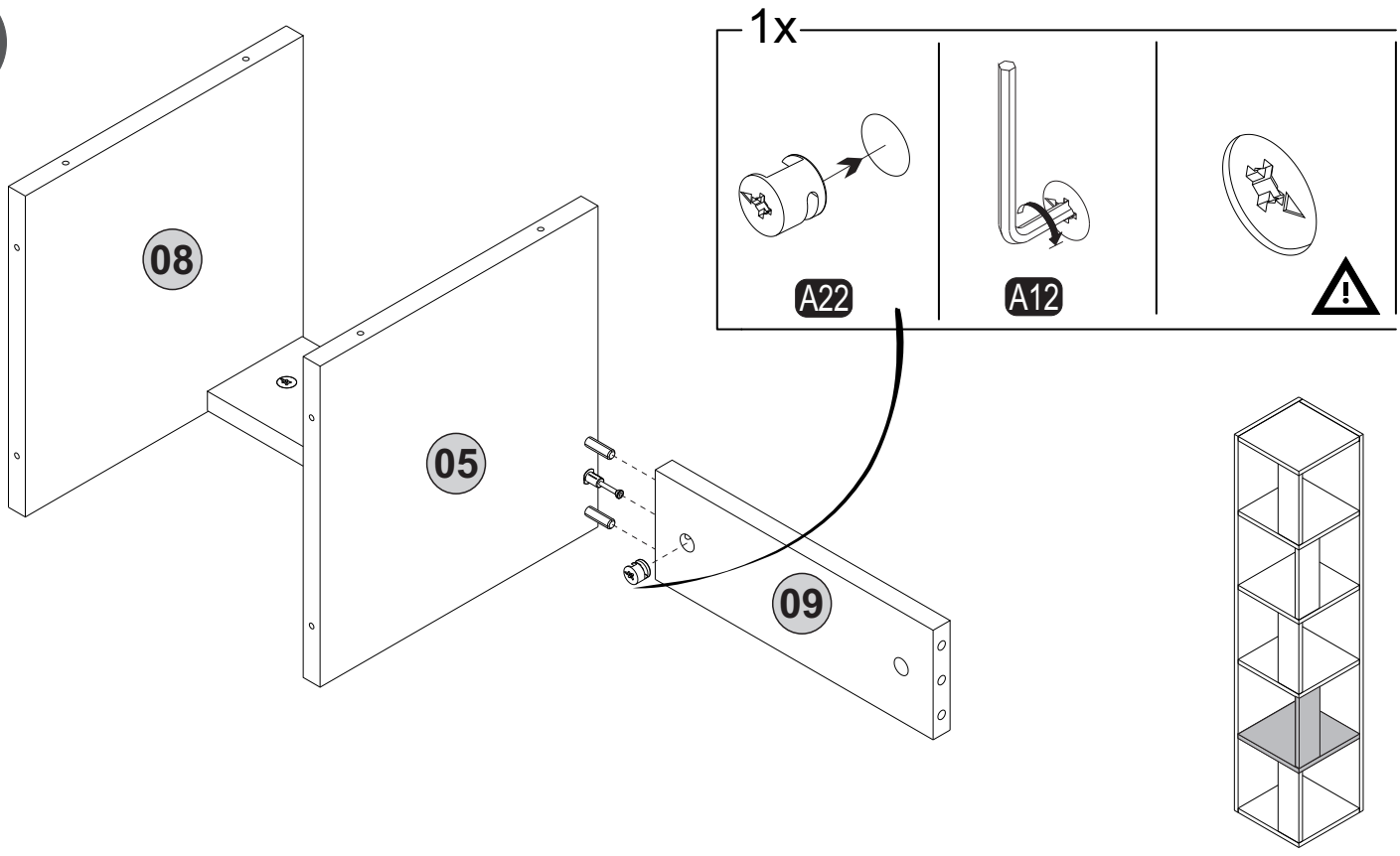

7

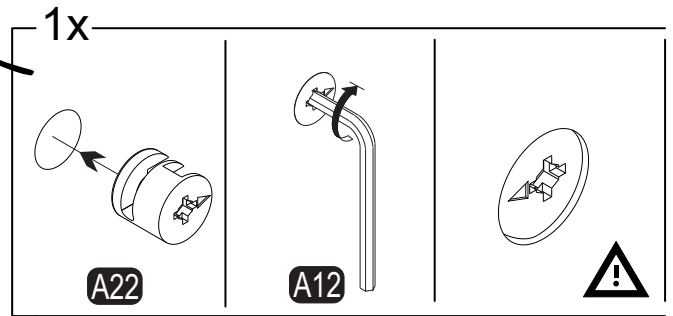
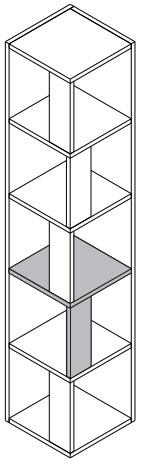
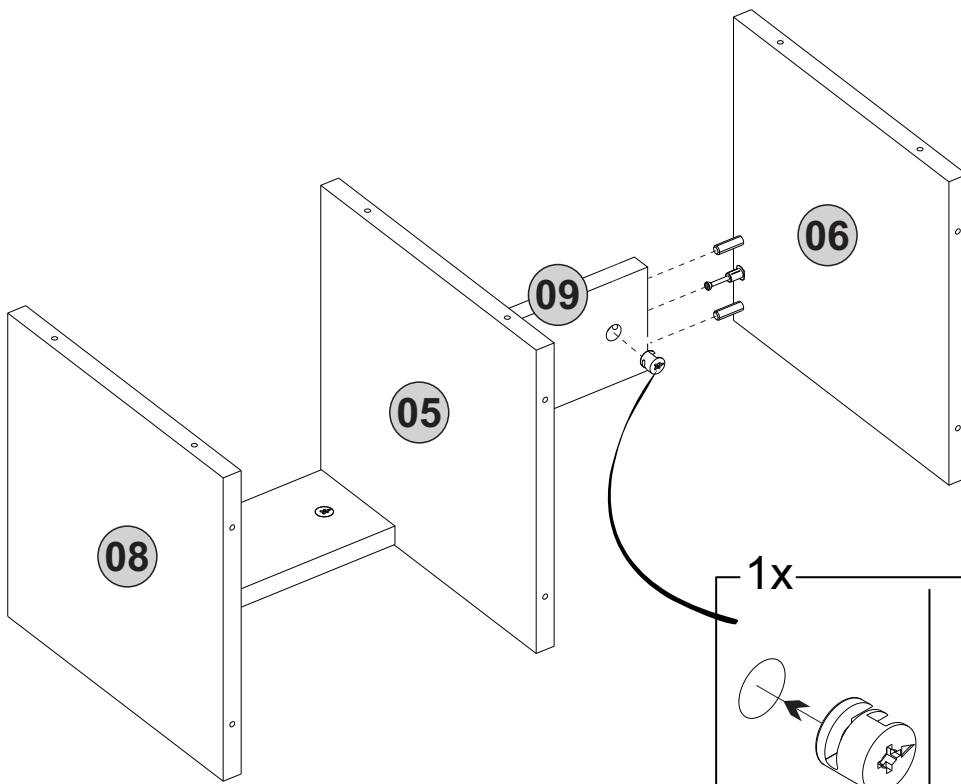

8

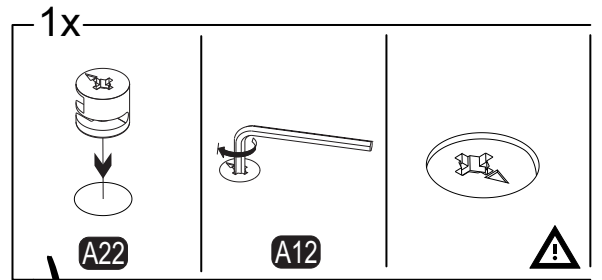
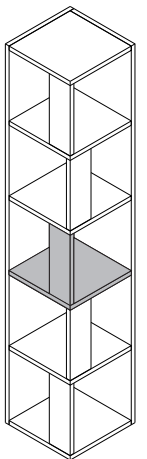
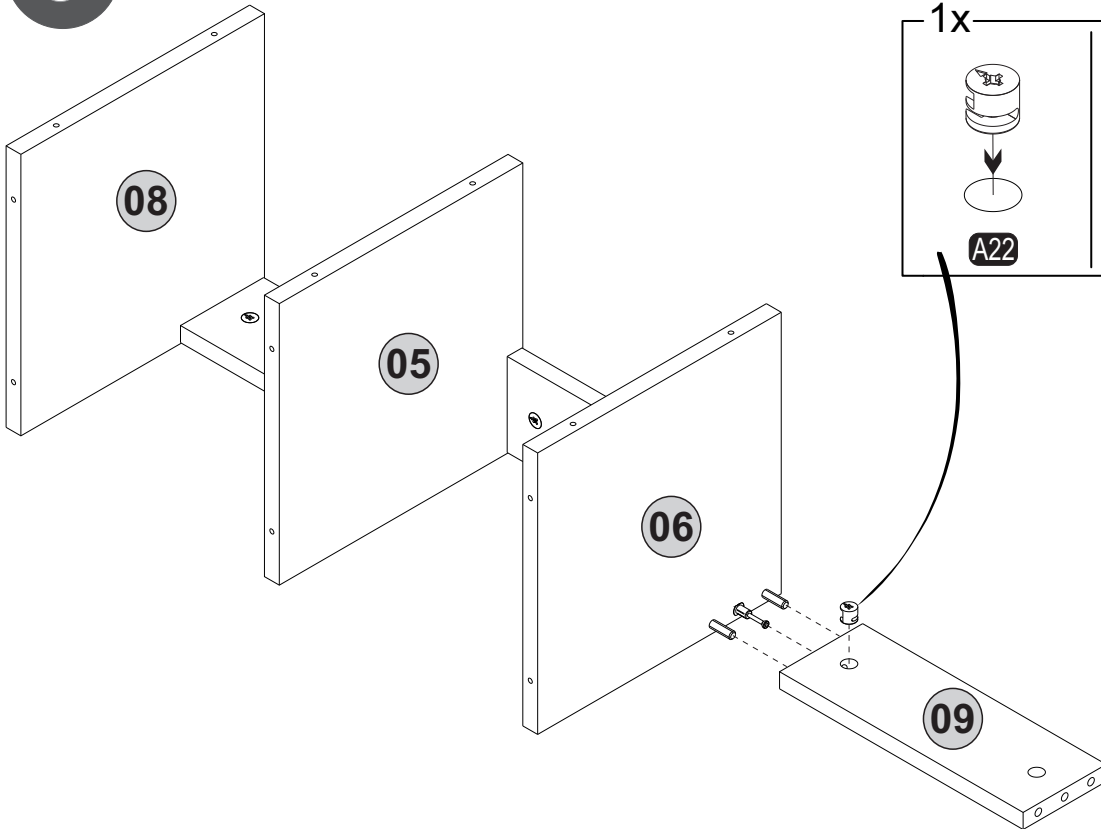

9

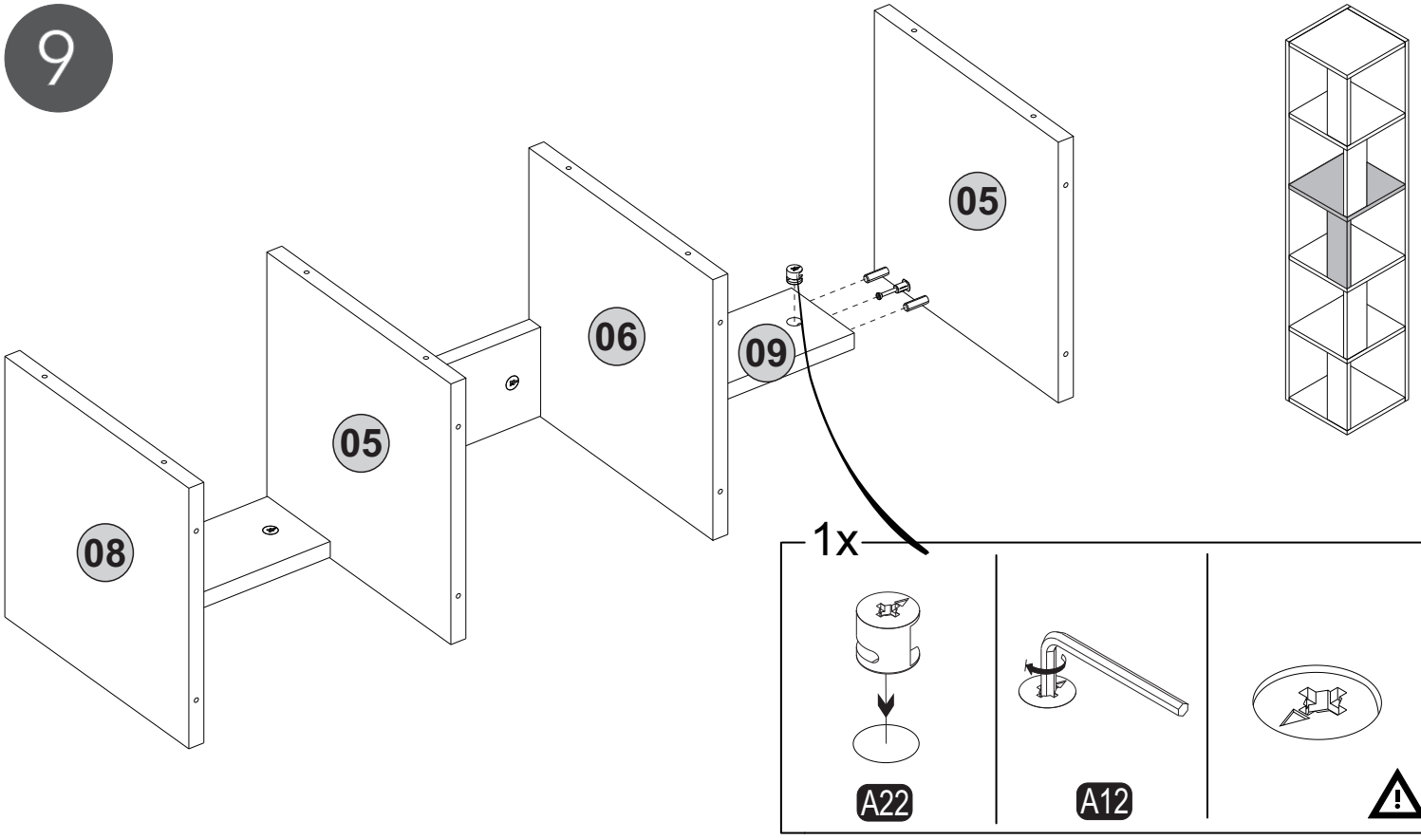

10

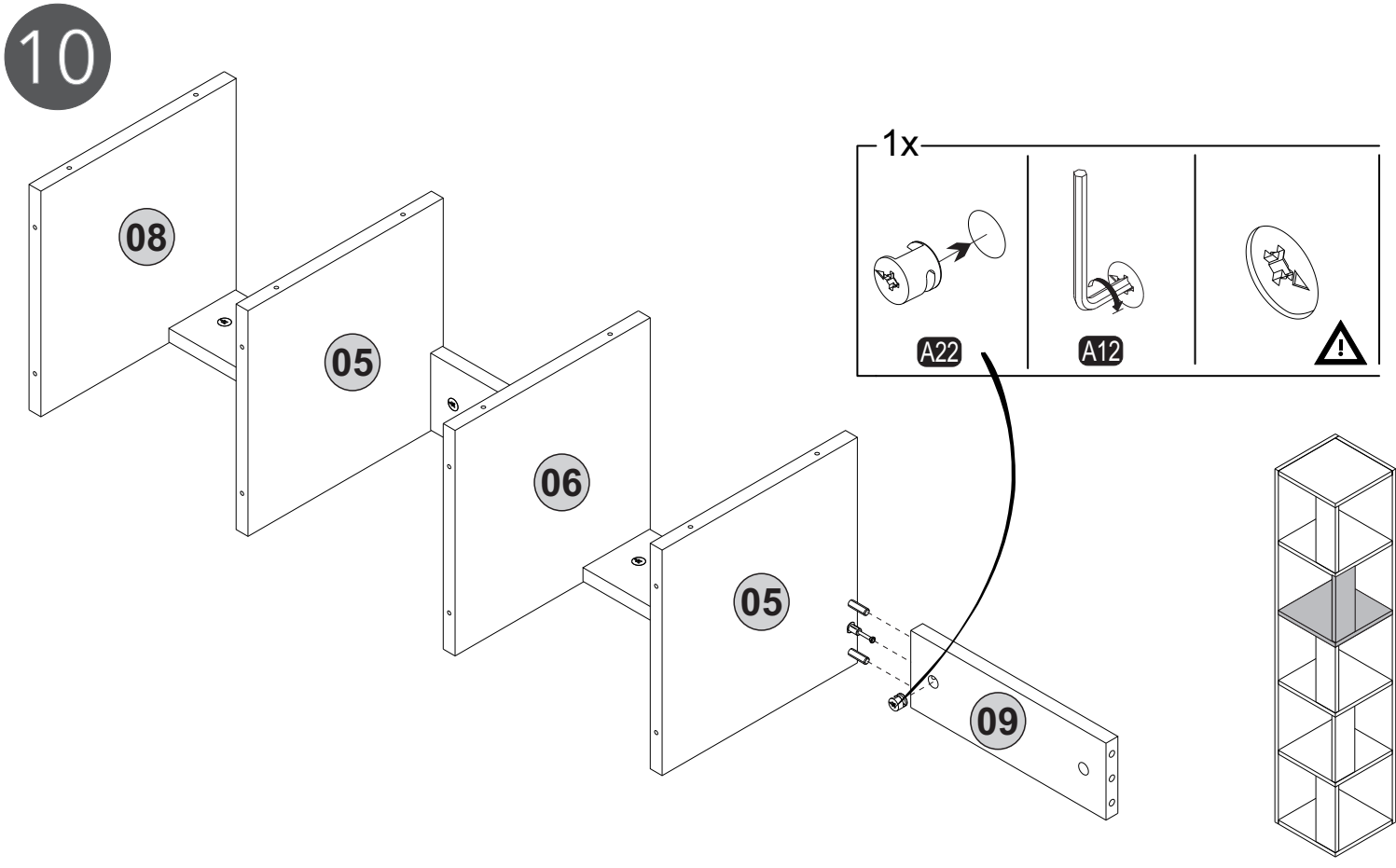

11

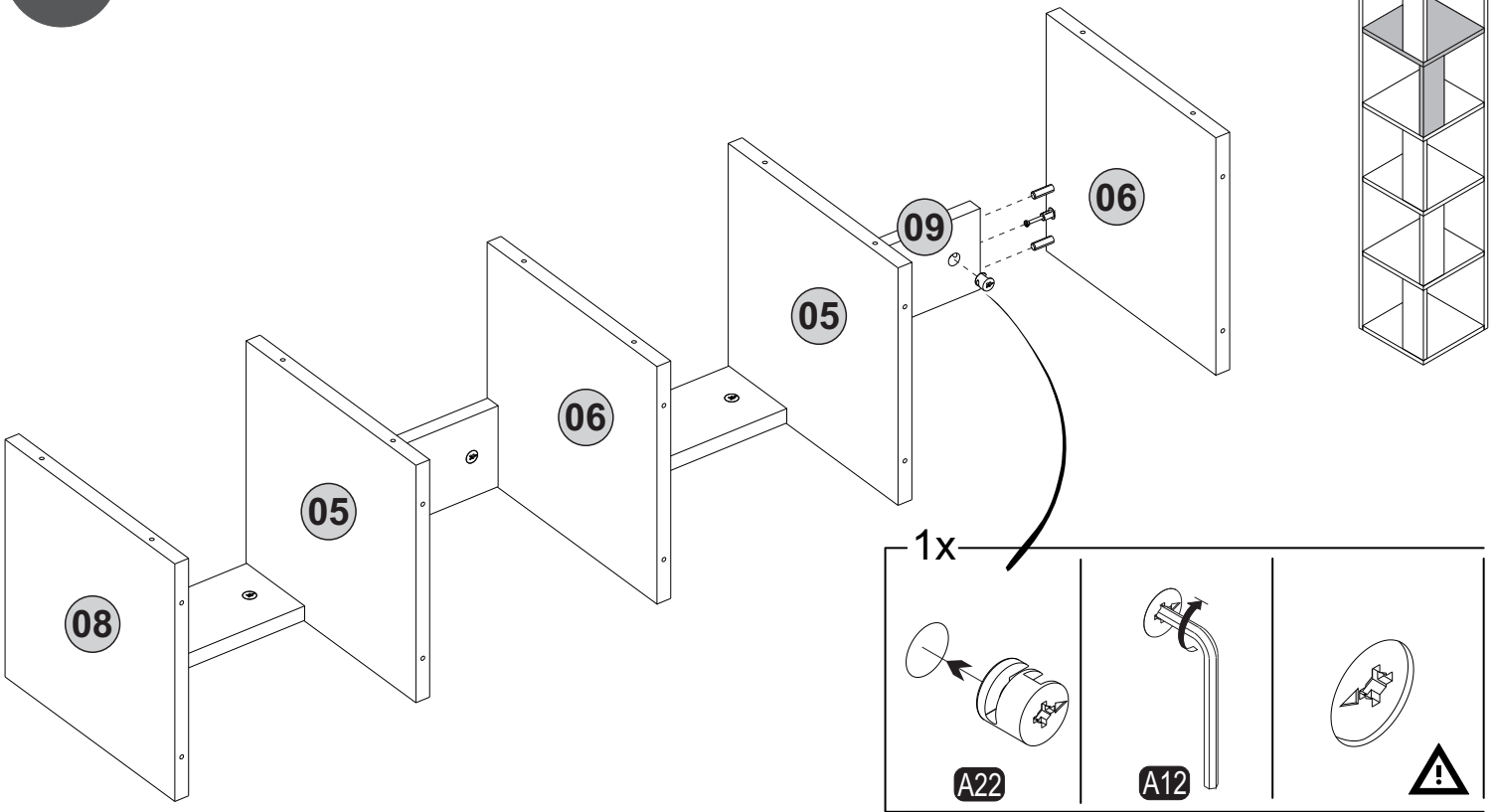

12

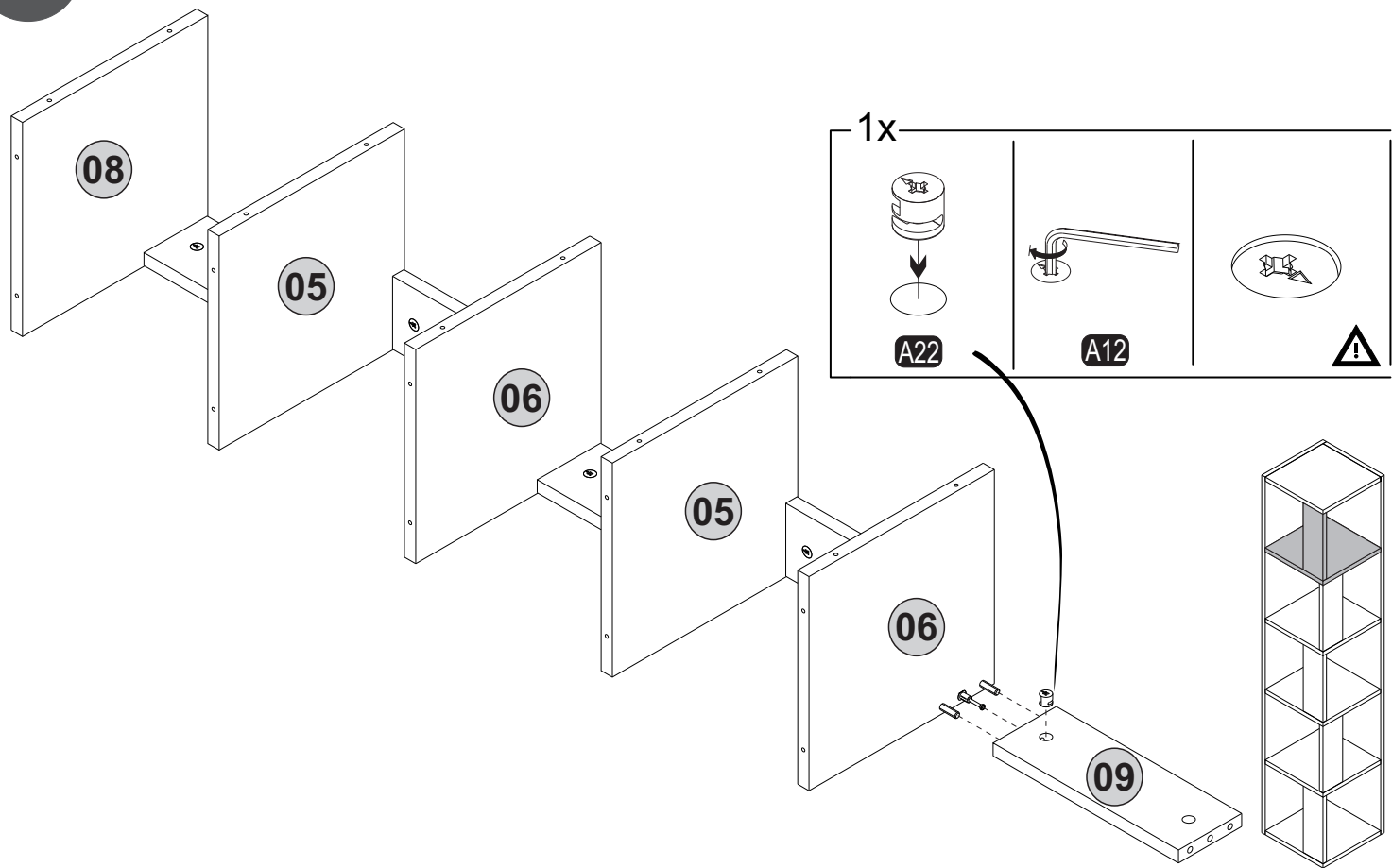

13

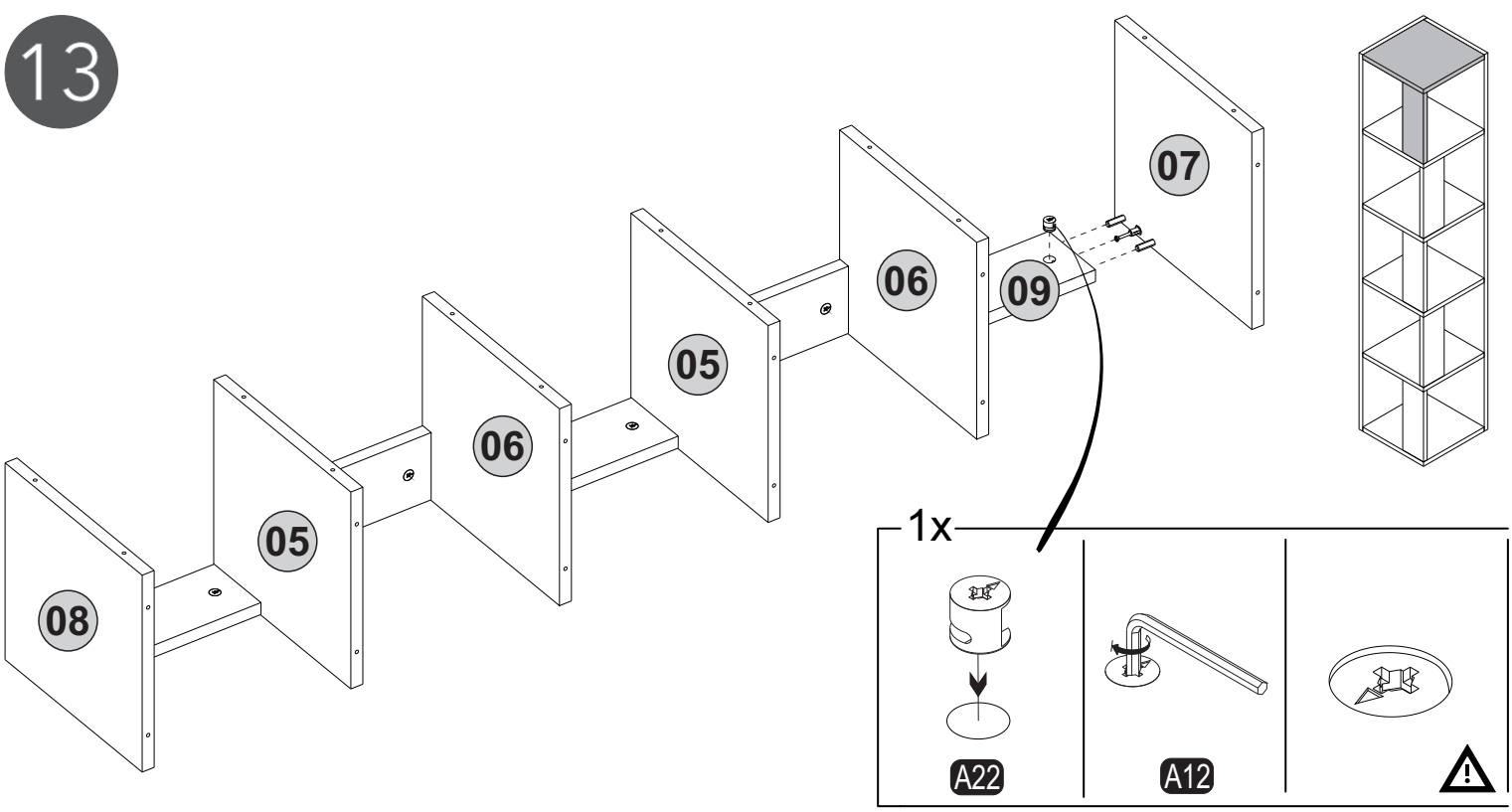

14

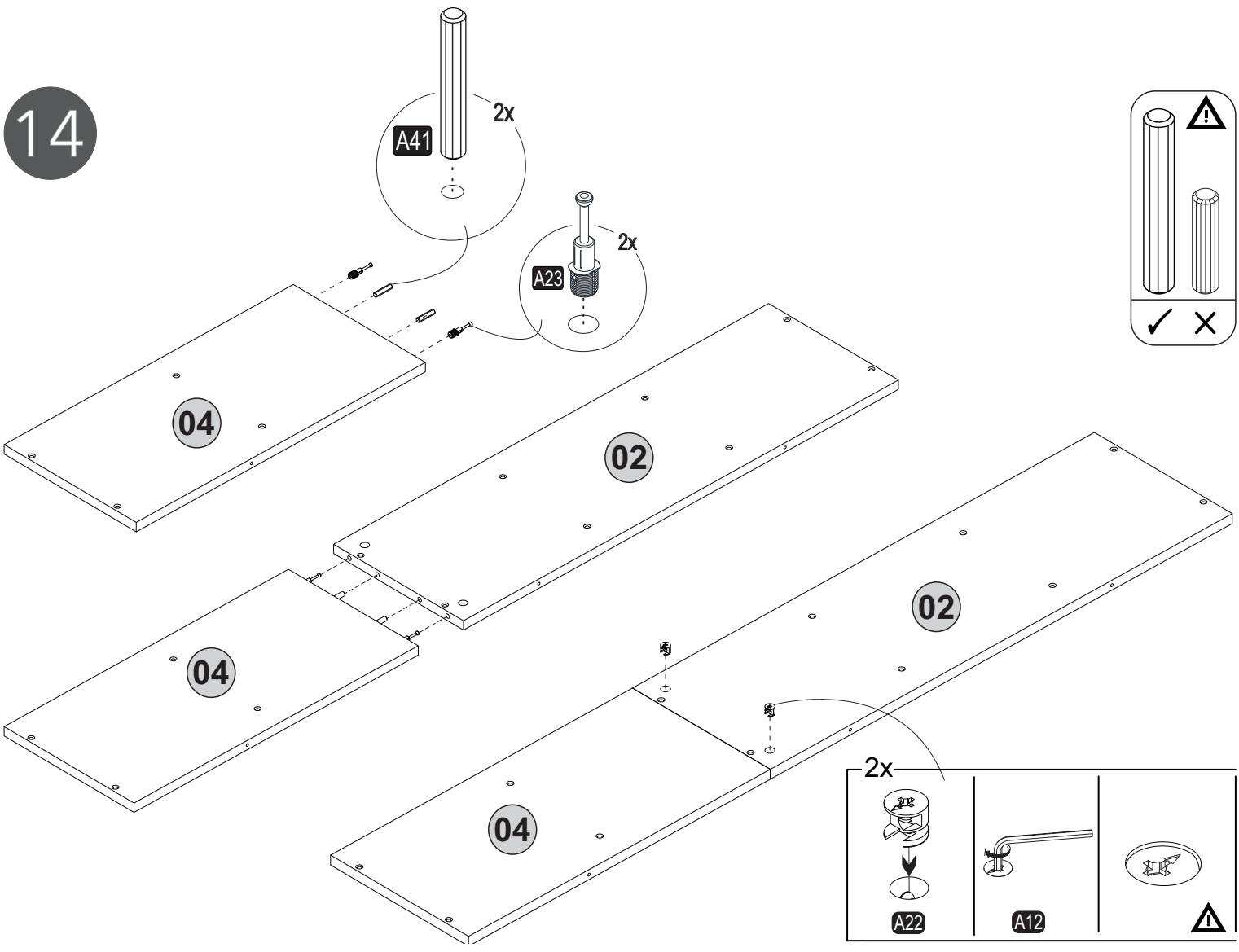

15

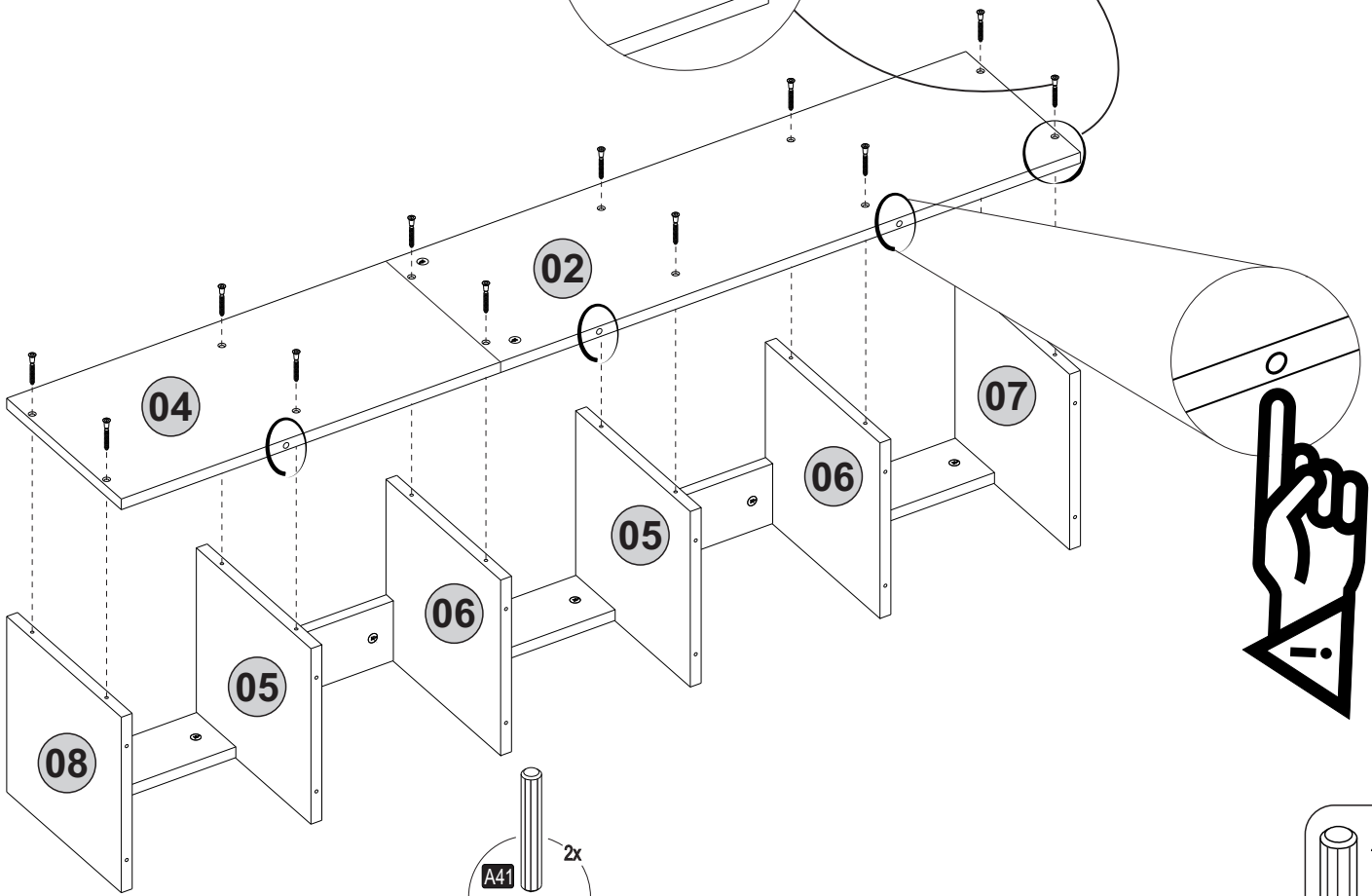
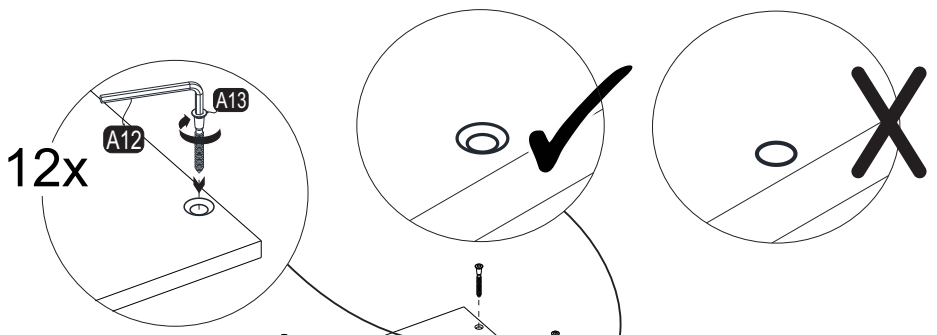

16

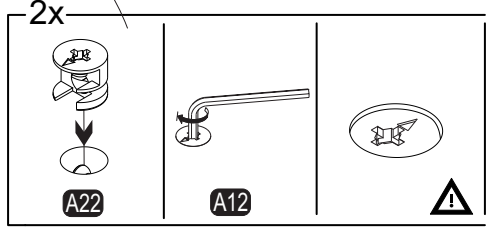
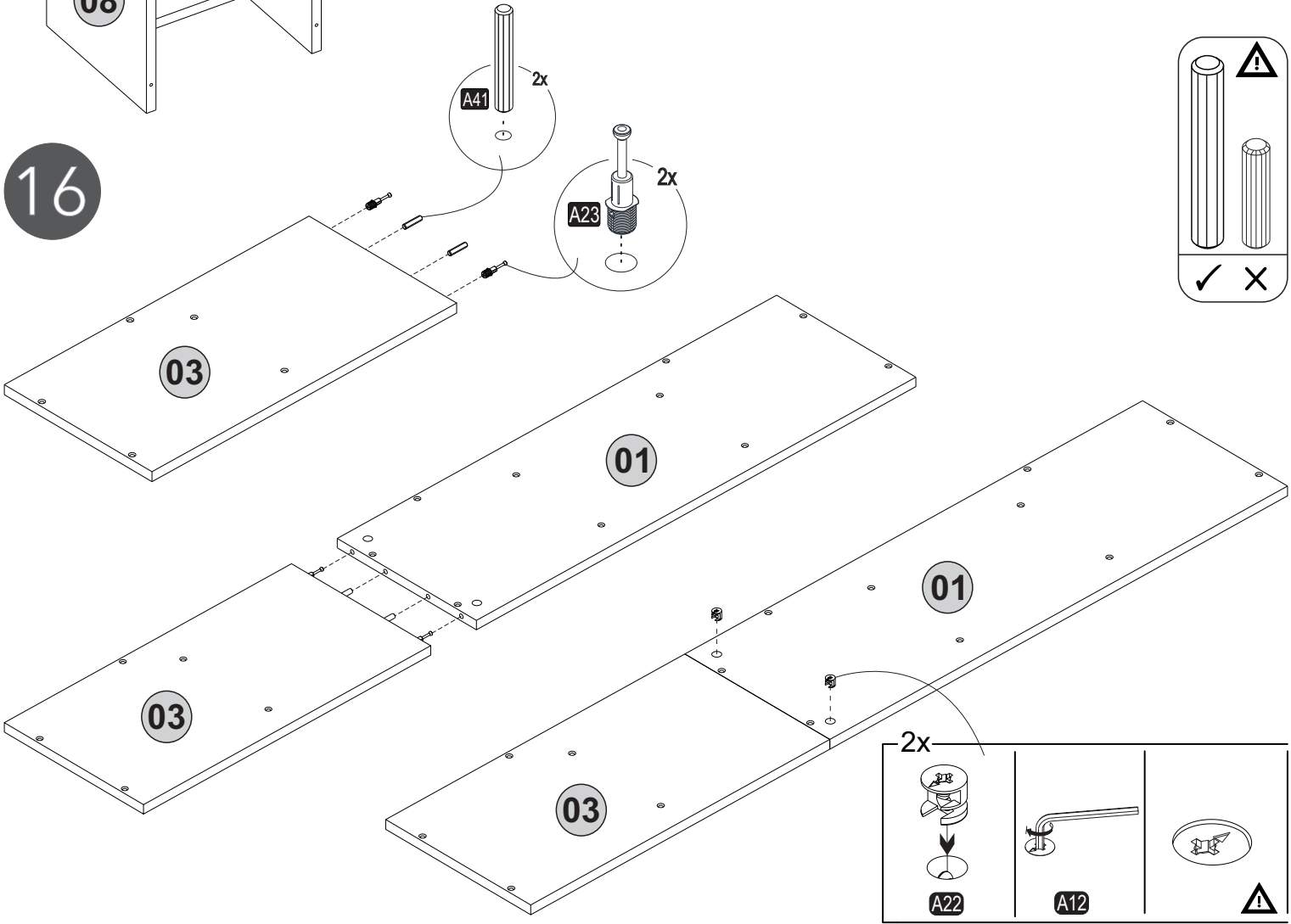

12x

