

GP041-0100,2

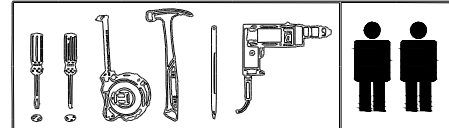

1/1
(A)
 PF
 2x
 PC
 1x
 PI
 2x
 M15
 1x



PF 1280x350 mm
 PI 837x75 mm
 PC 837x348 mm

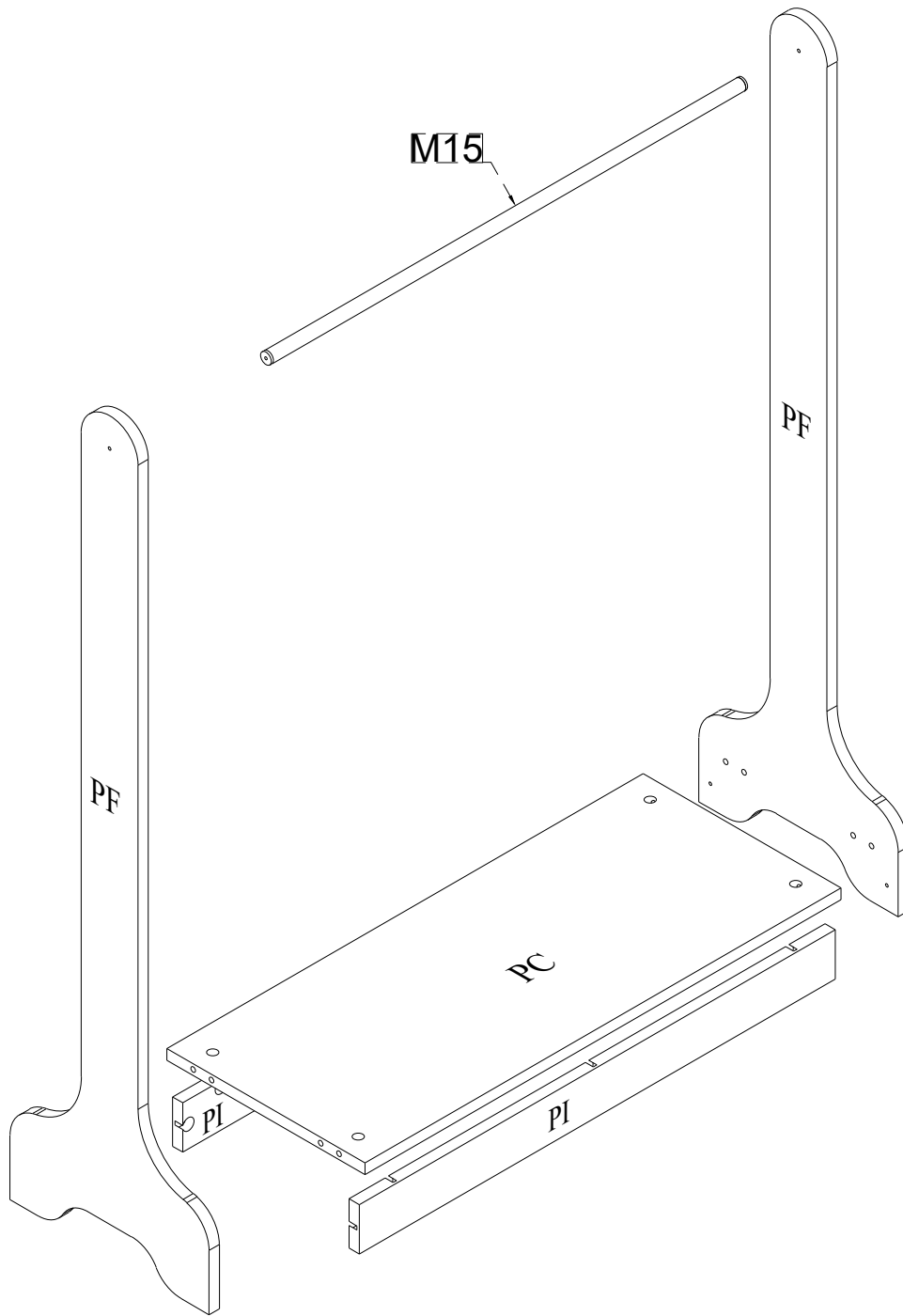

NO: H100023 4 X	NO: H100024 4 X	NO: P000101 Ø8 x 29 MM 4 X	NO : H100034 10 X	NO : H100029 Ø6x7,5 MM 10 X	NO:H100008 5x50 MM 2 X	NO:H100046 14 MM 02 X	

1

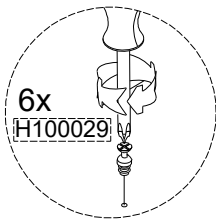
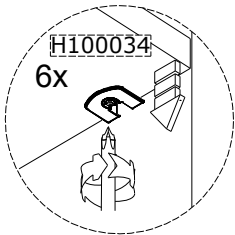
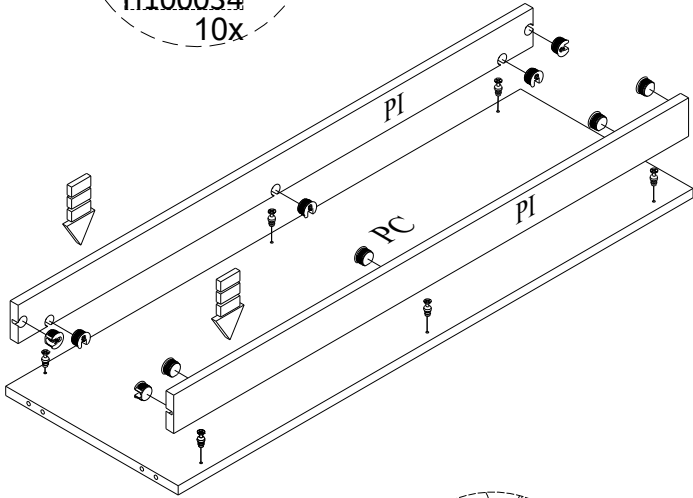
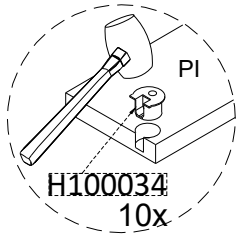

2

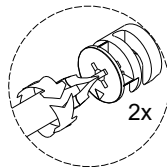
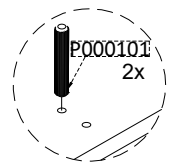
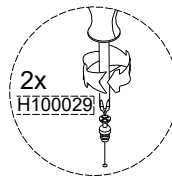

2

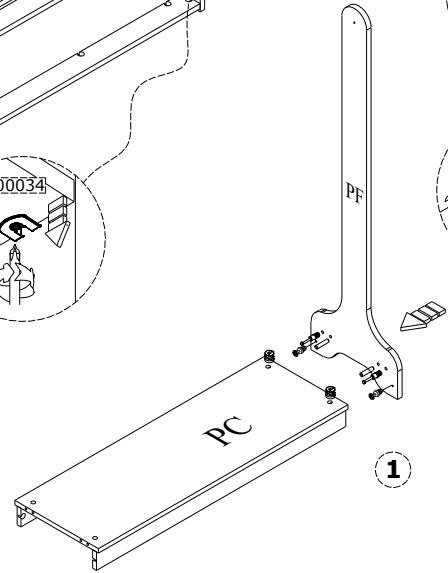
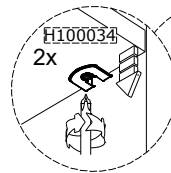
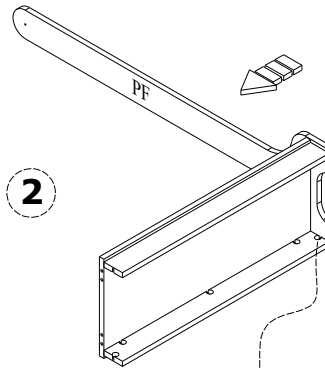

1

3

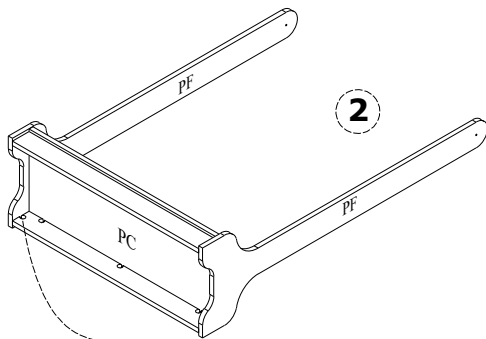

2

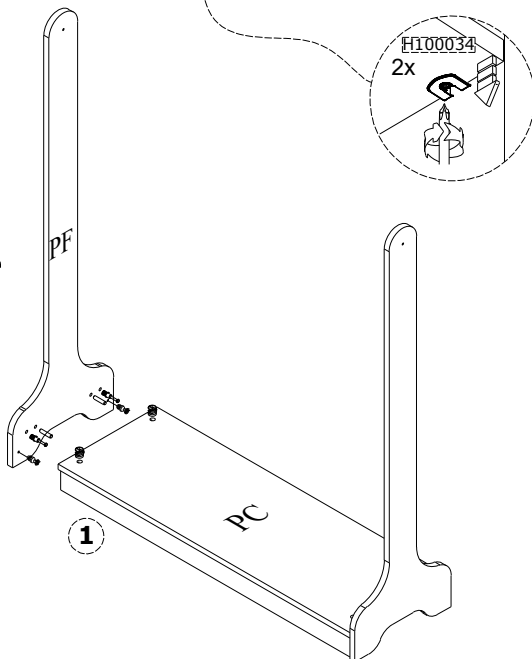
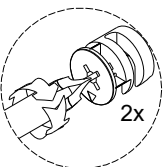
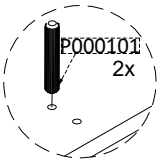

1

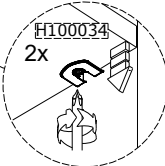

4

