

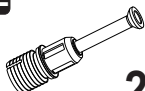







i GP042-0187,5

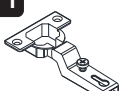

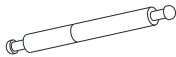
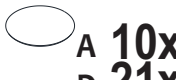
150 x 29,6 x 38,6cm

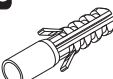
A01  31x	A02  27x	A03  18x	A13 MA  3x	A11 SPM  3x
A10 3,5x18 YHB  24x	A09 4x50 YHB  2x	A44  2x	A04  A 10x D 21x	A16  A 2x
D69 Ø8 Lik RKT  6x	D41 5x70 YHB  6x	A41  6x	A28  28x	

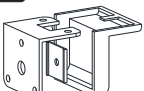
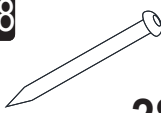
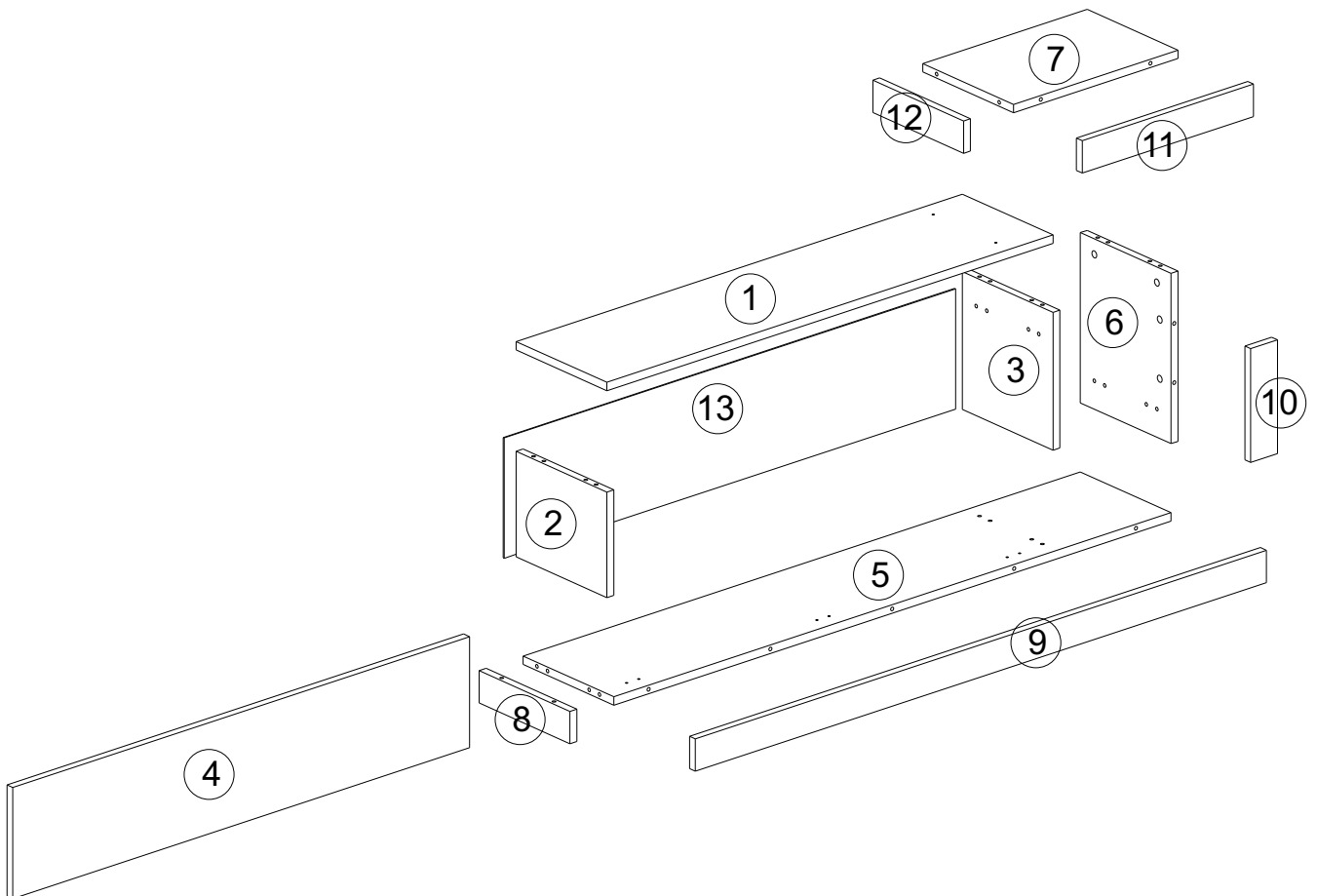

1

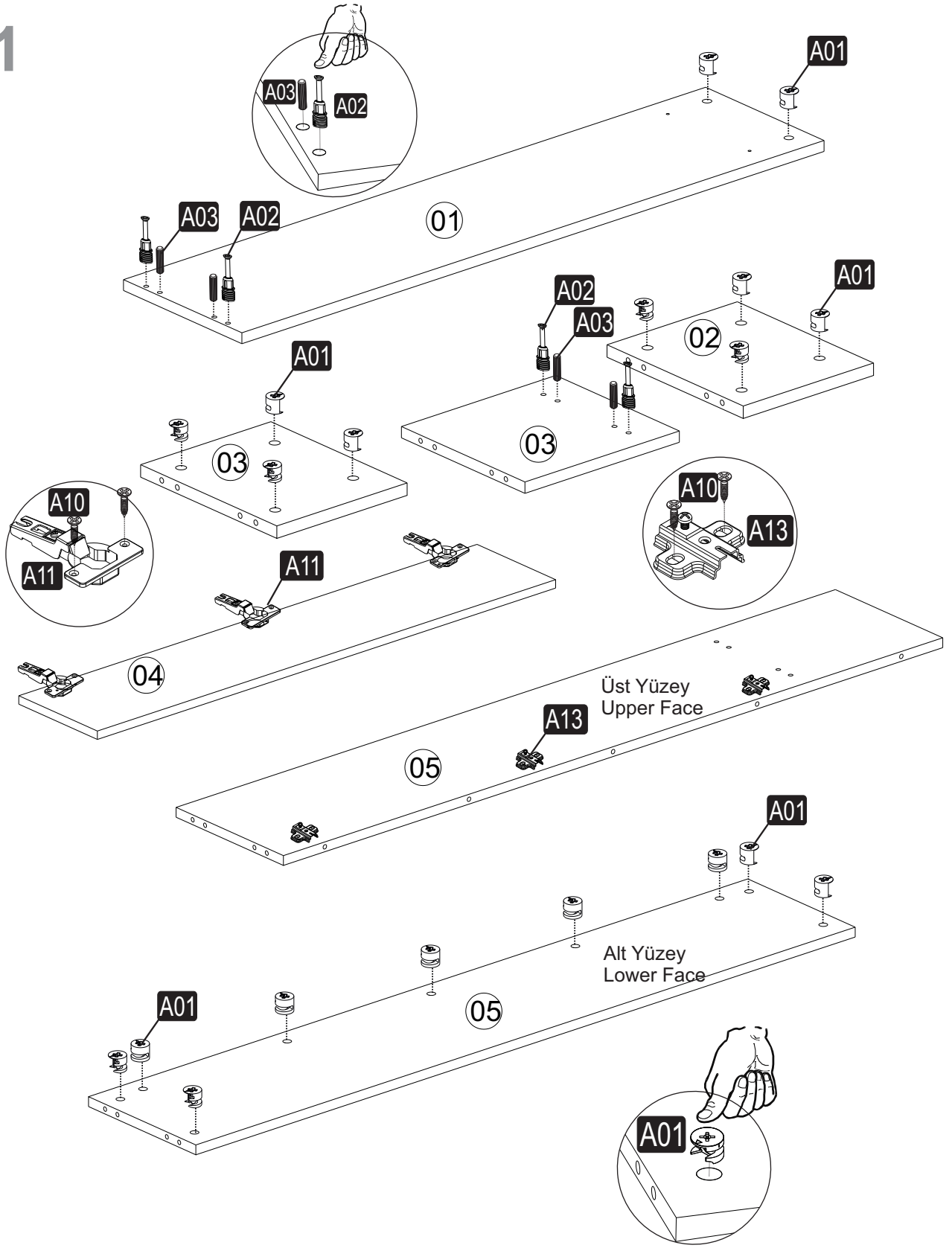

2

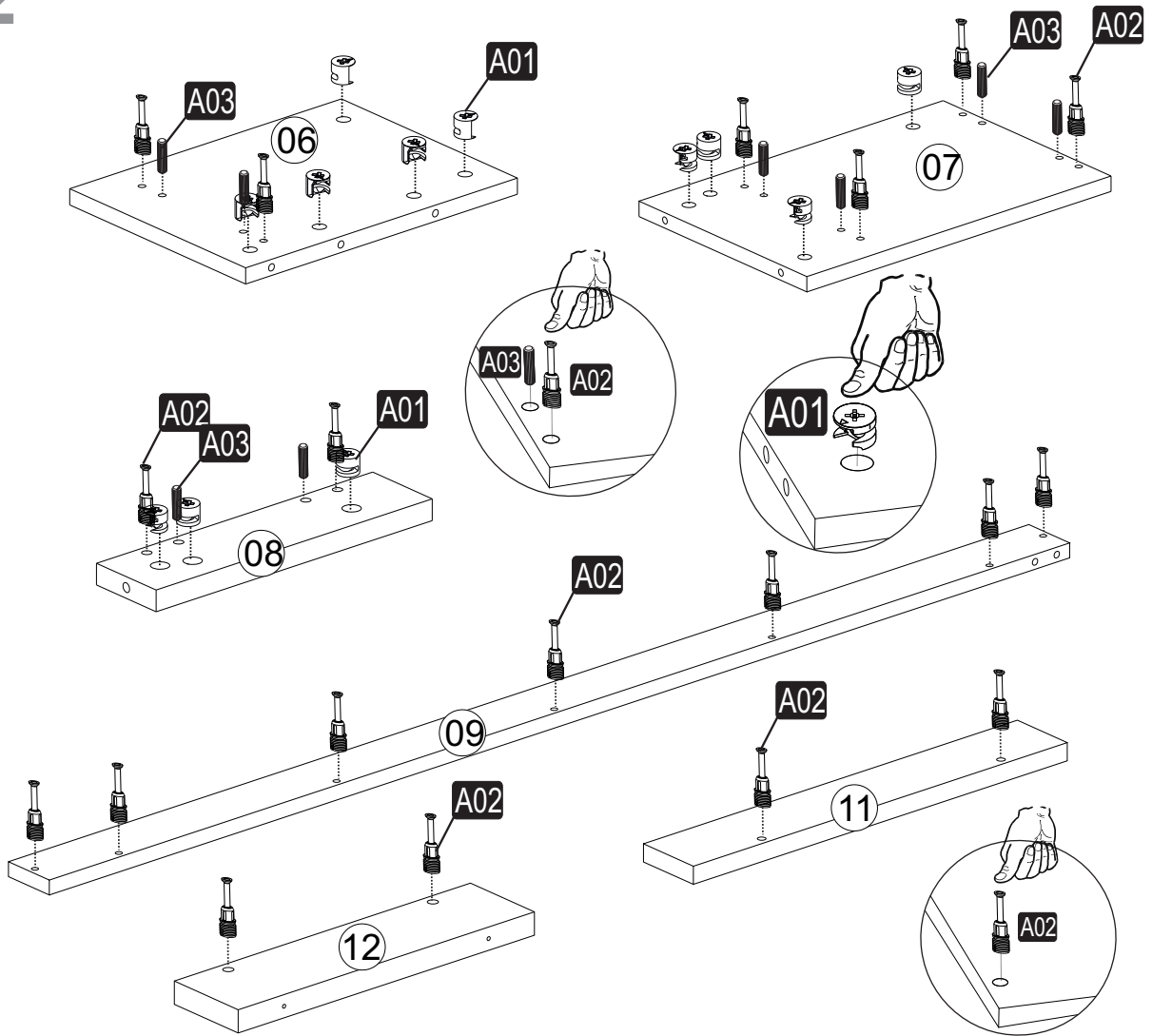

3

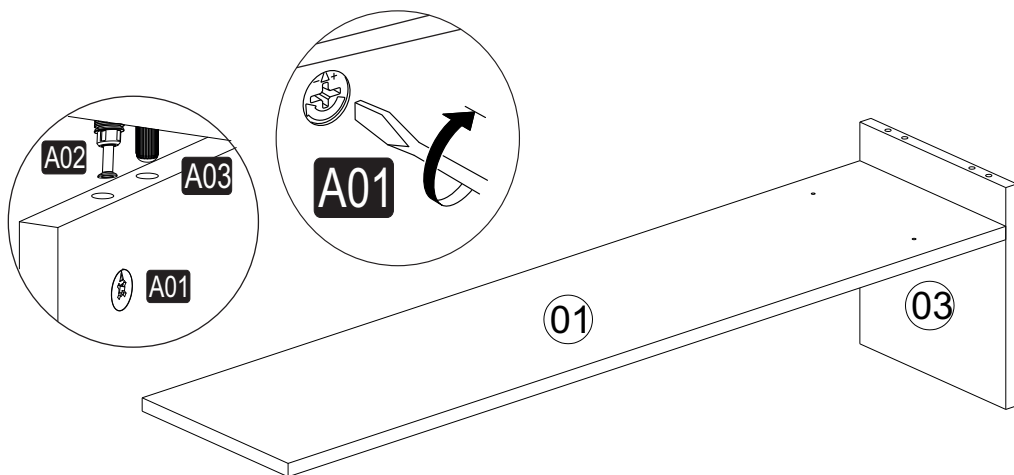

4

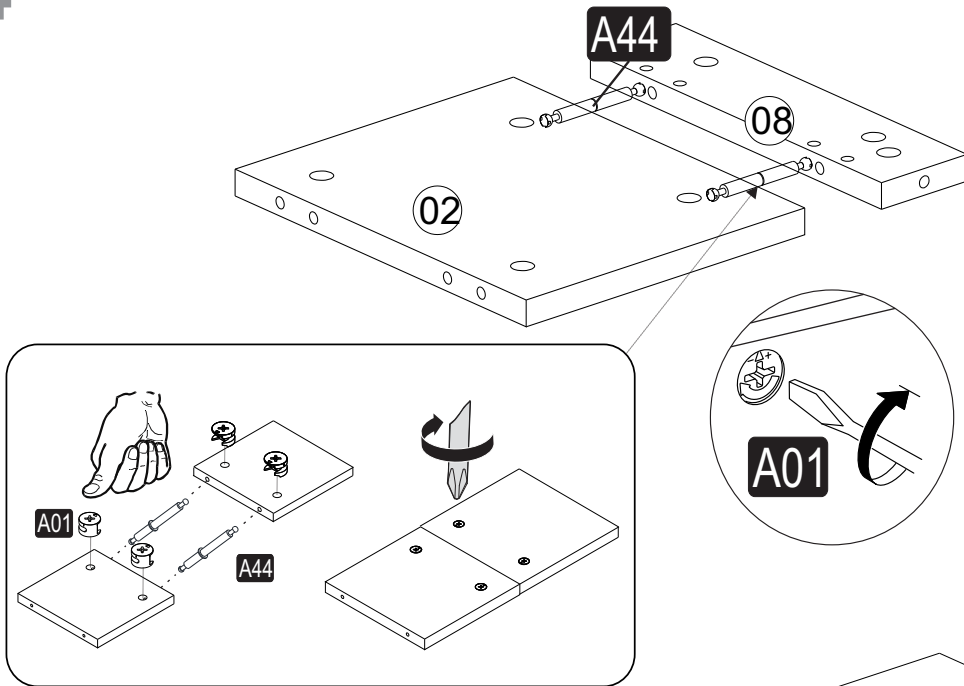

5

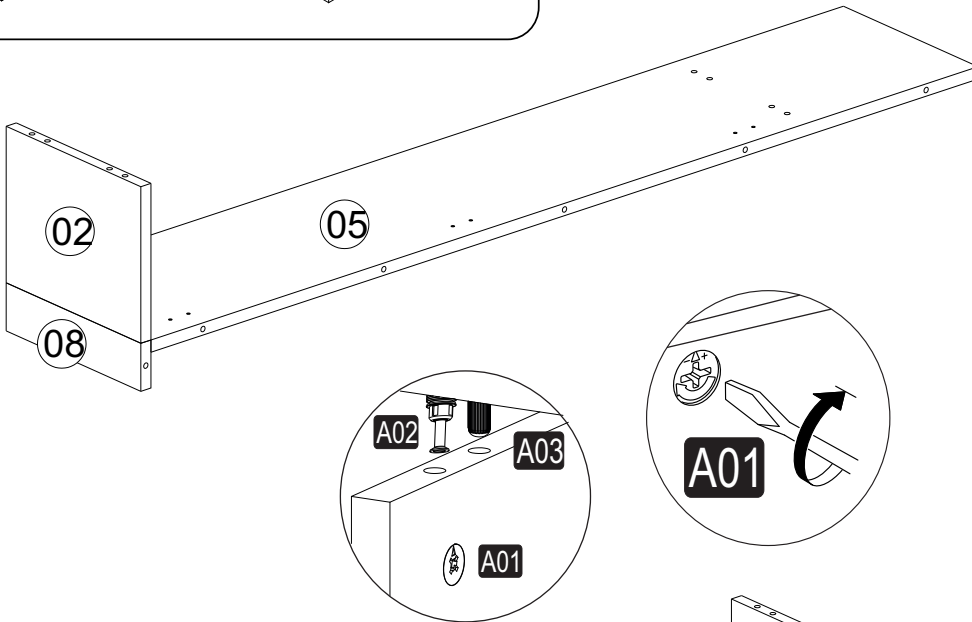

6

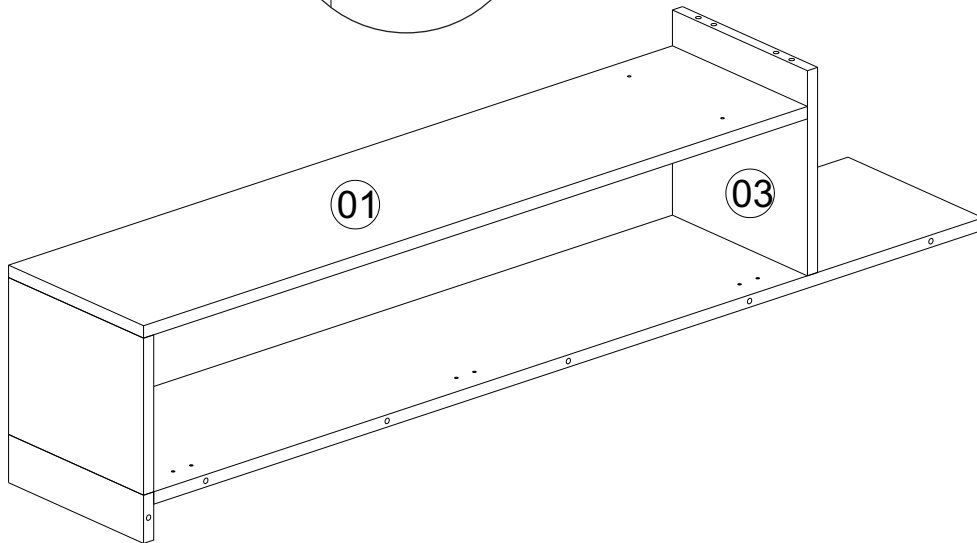

7

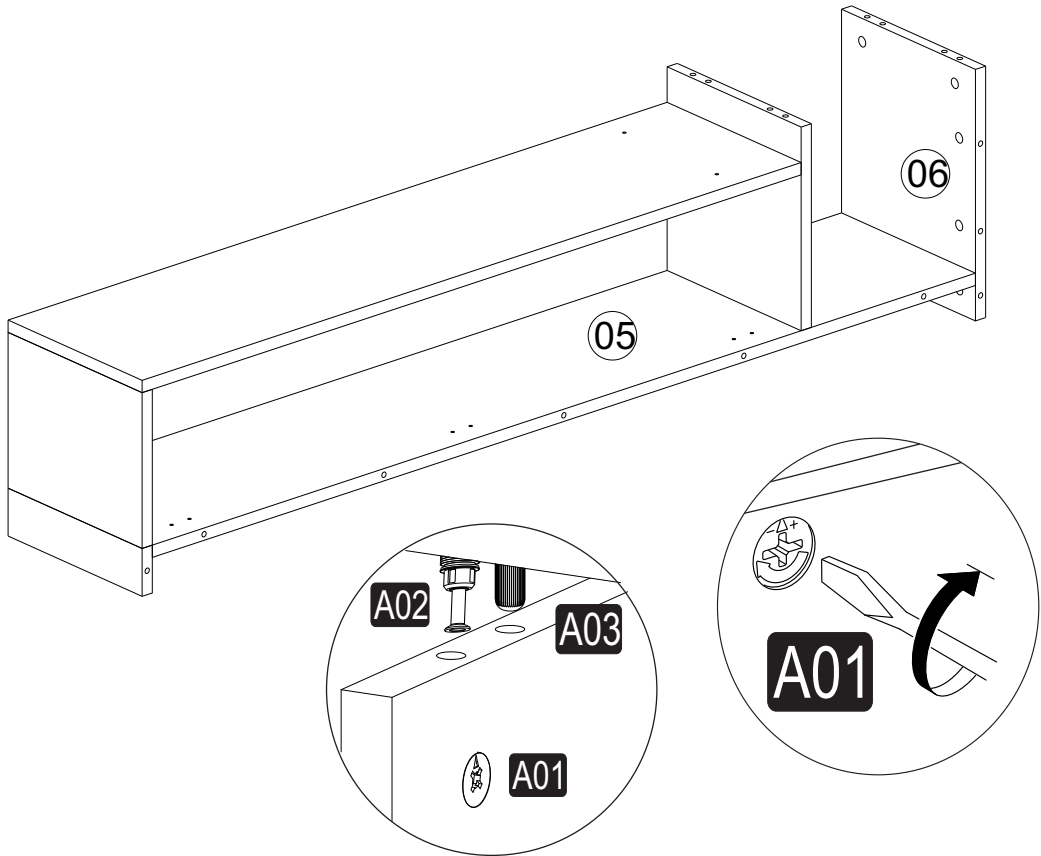

8

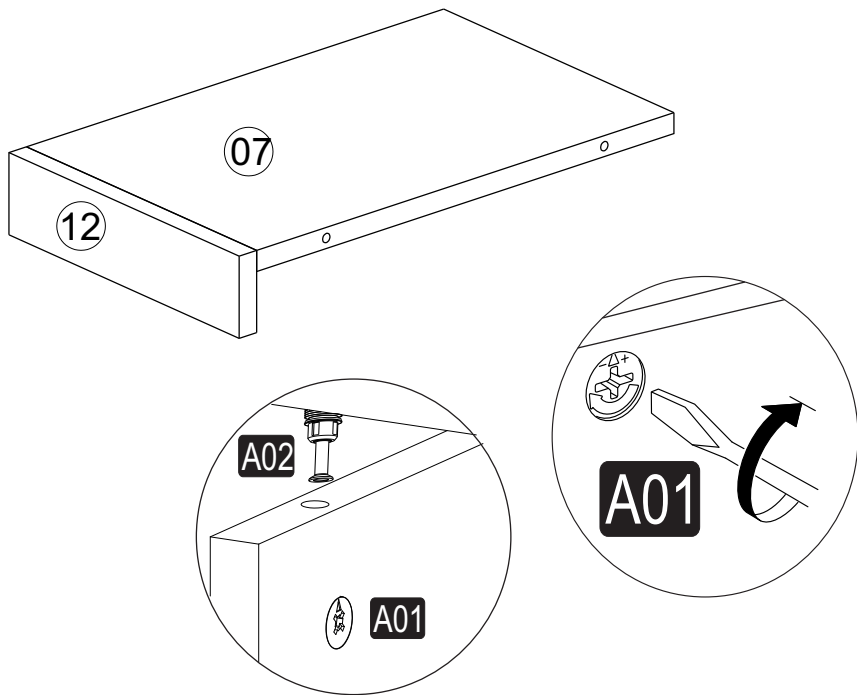

9

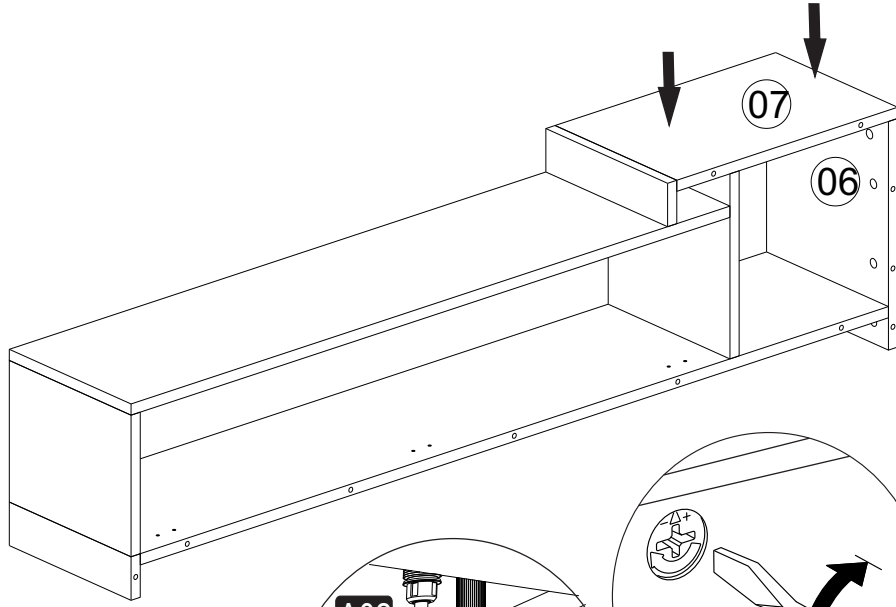

10

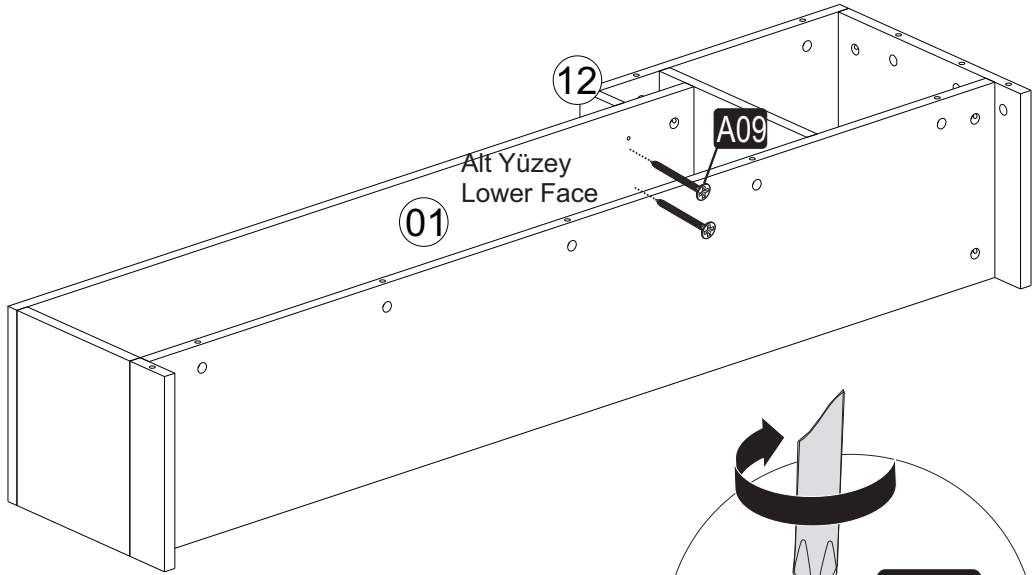

11

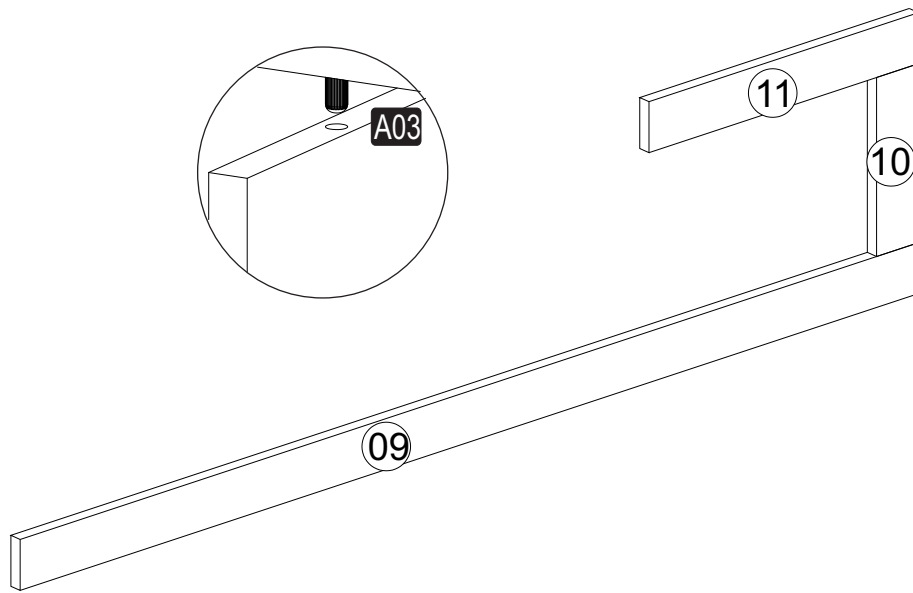

12

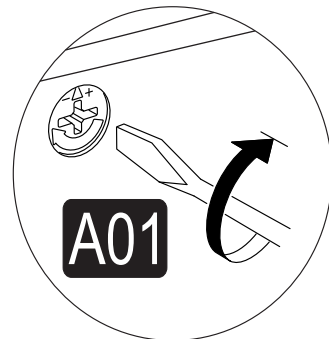
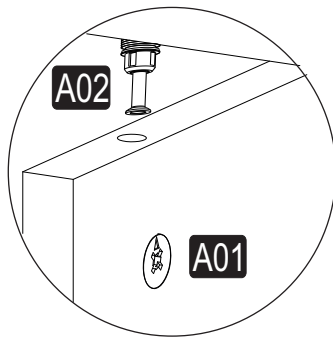
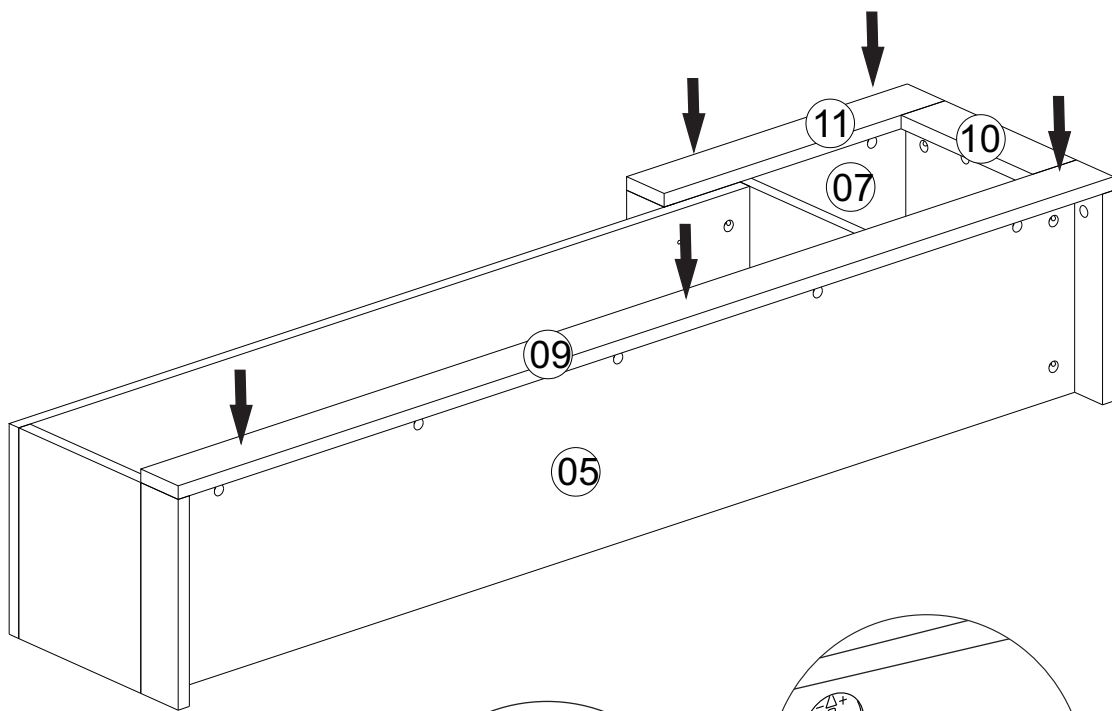

13

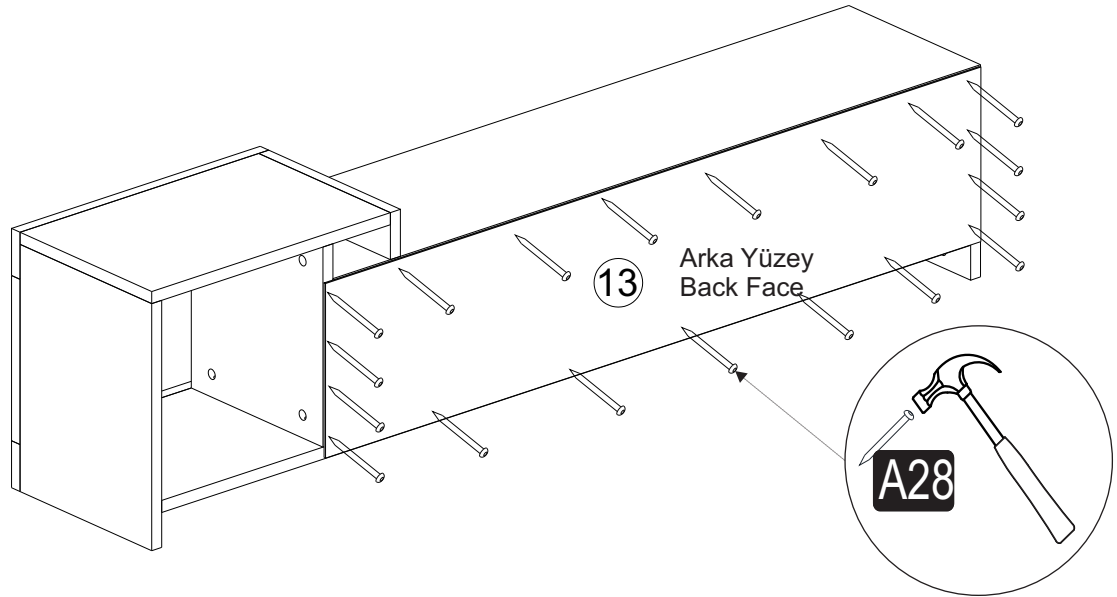

14

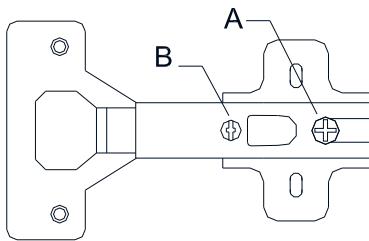
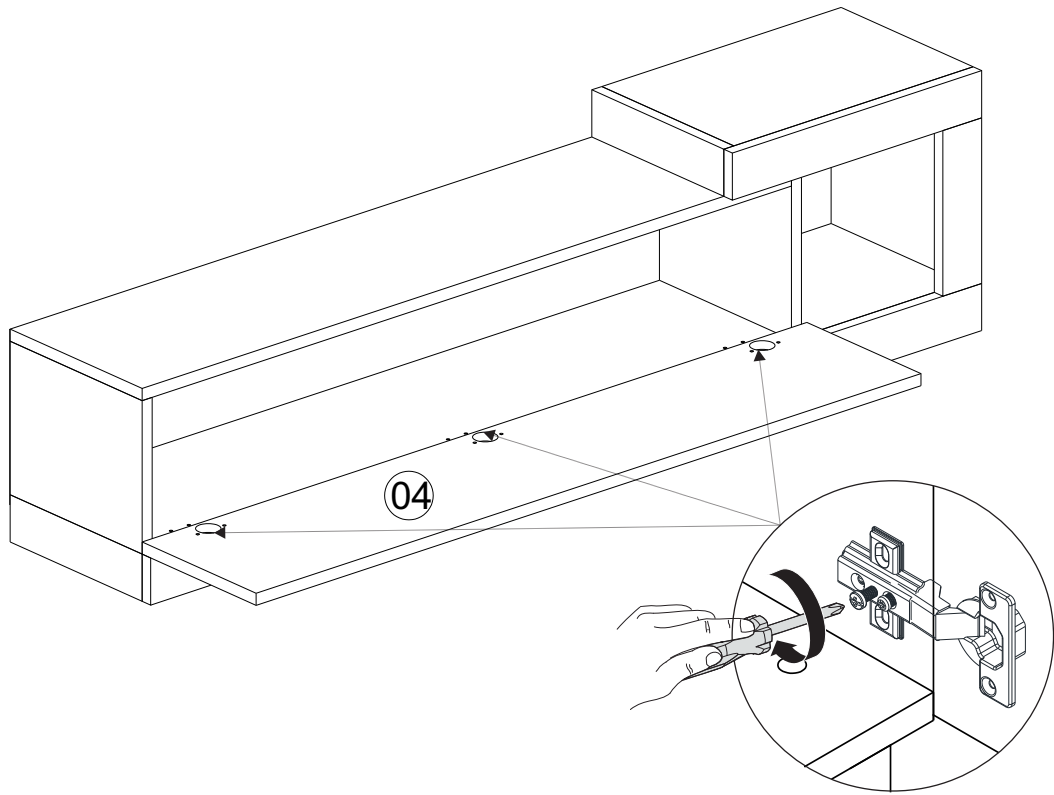

A=
B =

/ to connect the hinge to the door
/ to arrange the door

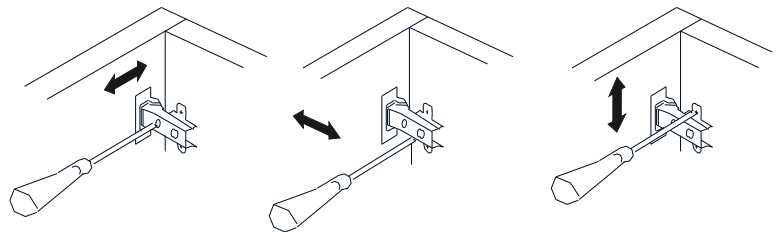

arrows to show the directions for arrangement of doors.

15

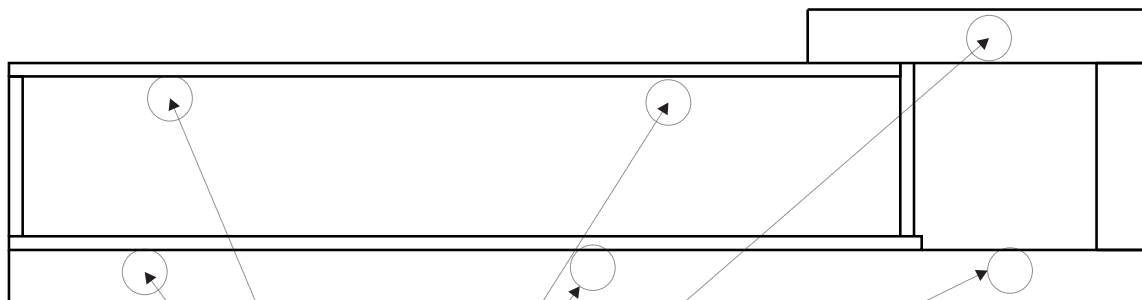

PART-1

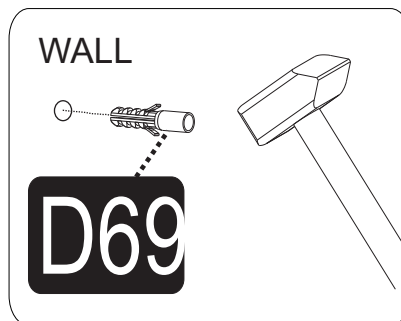
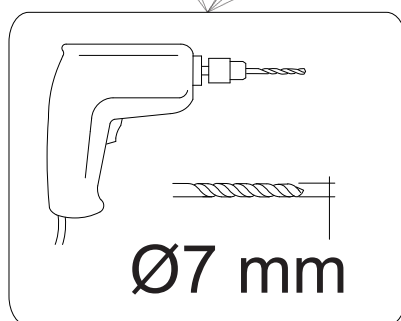

PART-2

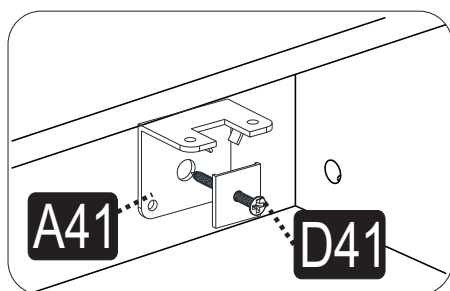

PART-3

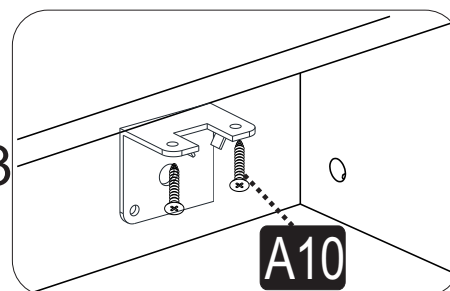

PART-4

