

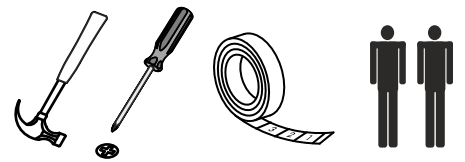

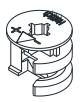

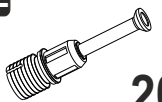

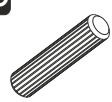

**i** GP042-0267,2

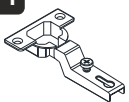
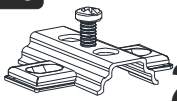
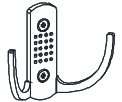
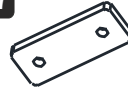

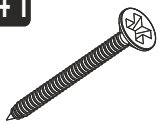
60 x 38,2 x 190cm

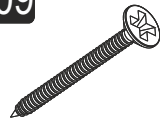
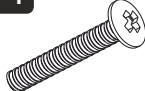

<b>A01</b>  <b>20x</b>	<b>A02</b>  <b>20x</b>	<b>A03</b>  <b>20x</b>	<b>A04</b>  <b>A 20x</b>	<b>A11</b> SPM  <b>2x</b>
<b>A13</b>  <b>2x</b>	<b>A36</b>  <b>3x</b>	<b>A27</b>  <b>4x</b>	<b>E17</b>  <b>1x</b>	<b>D69</b> Ø8  <b>1x</b>
<b>D41</b> 5x70 YHB  <b>1x</b>	<b>A10</b> 3,5x18 YHB  <b>23x</b>	<b>A09</b> 4x50 YHB  <b>4x</b>	<b>A14</b> M4x22  <b>2x</b>	<b>A24</b> 128 mm  <b>1x</b>

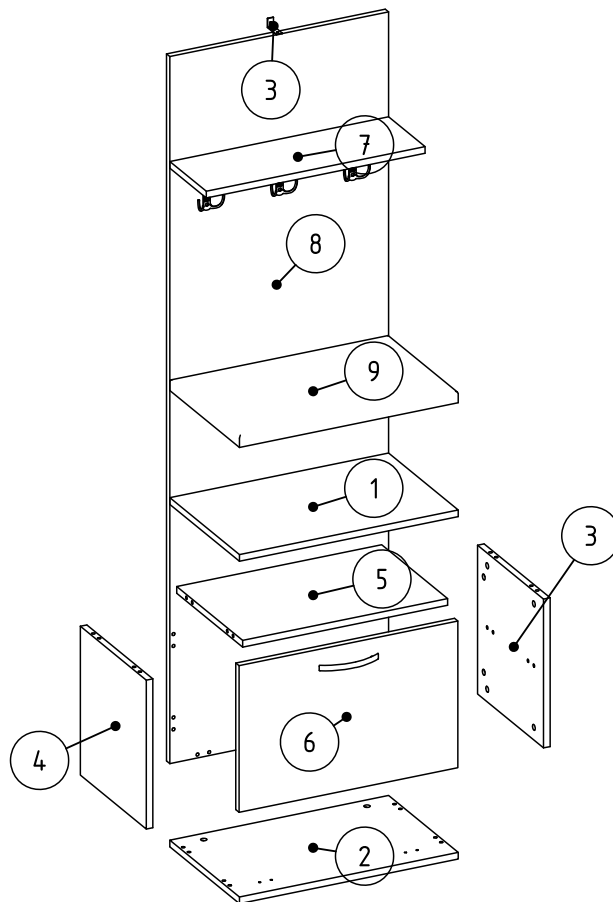

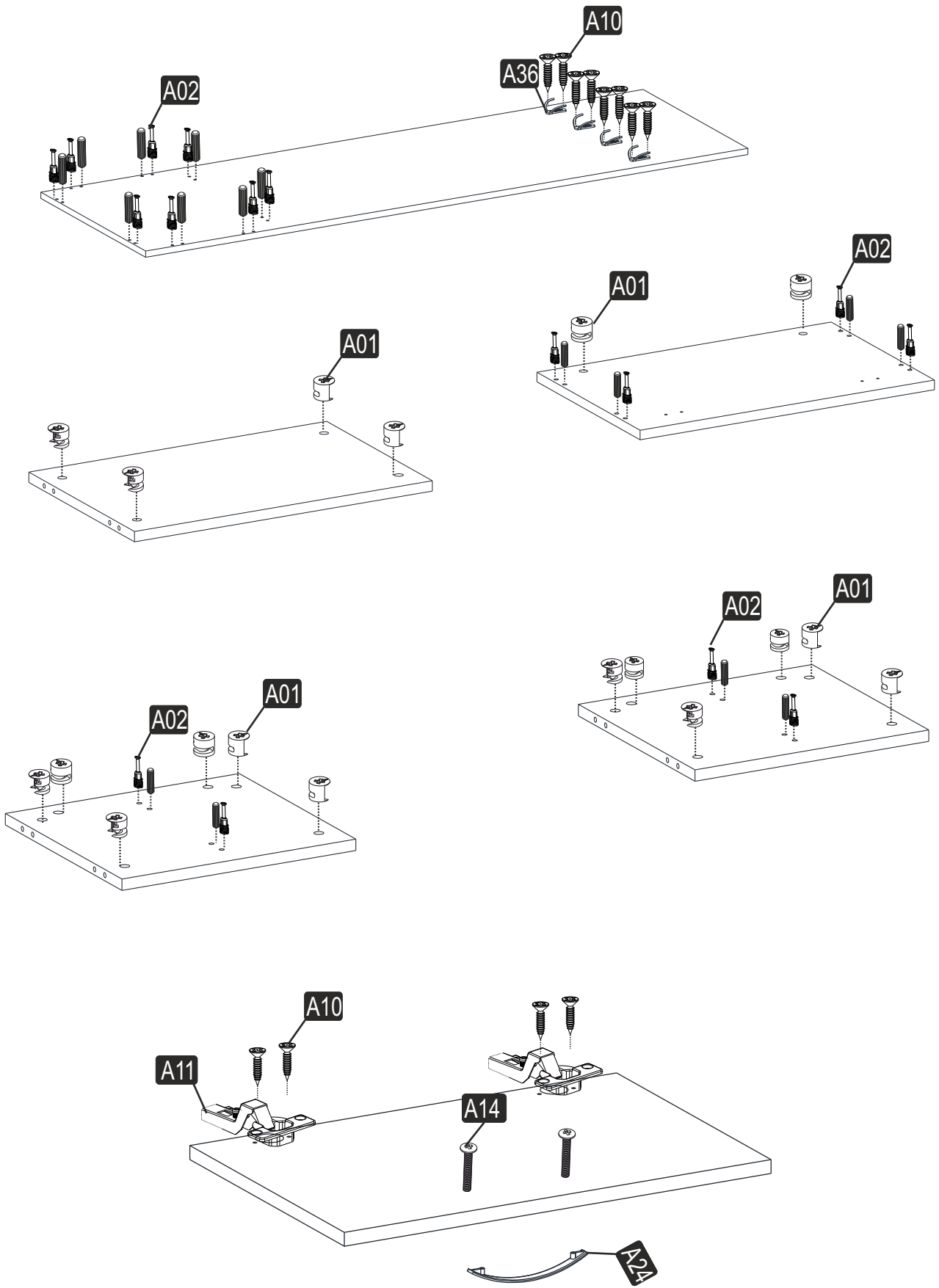

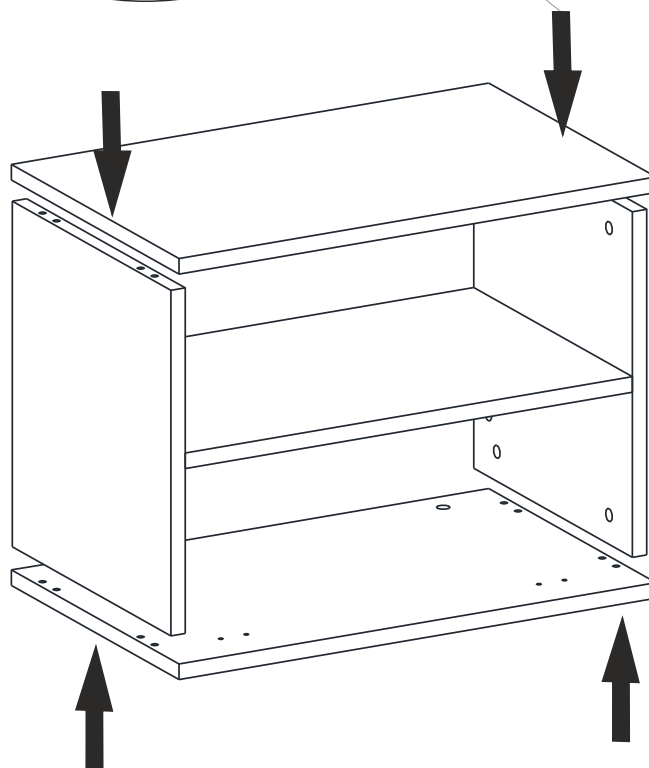
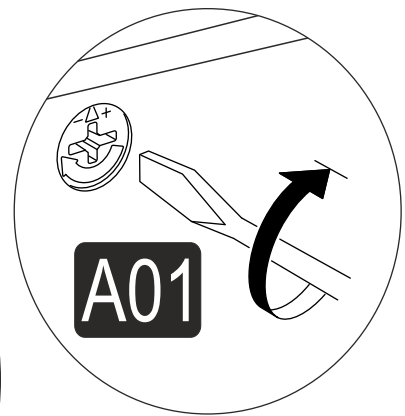
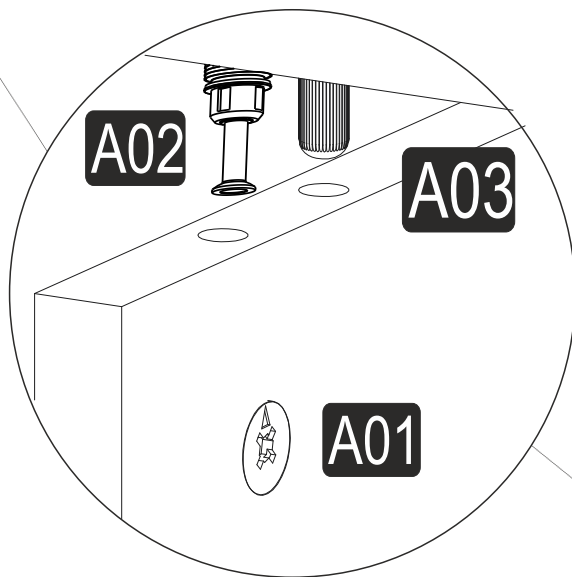
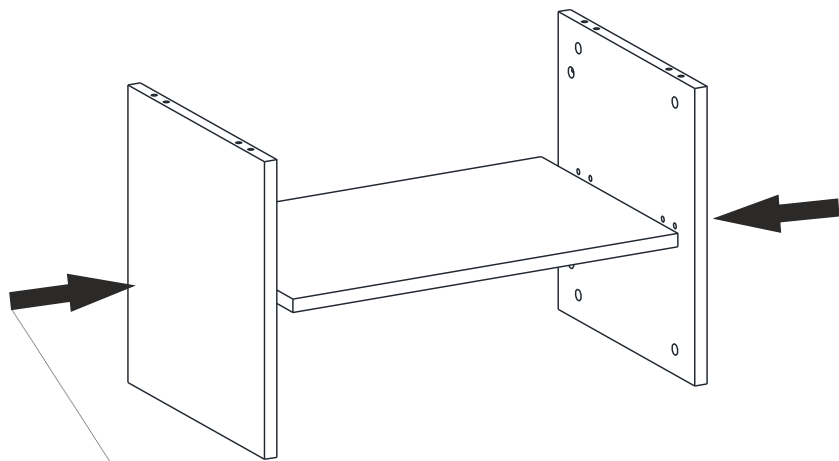

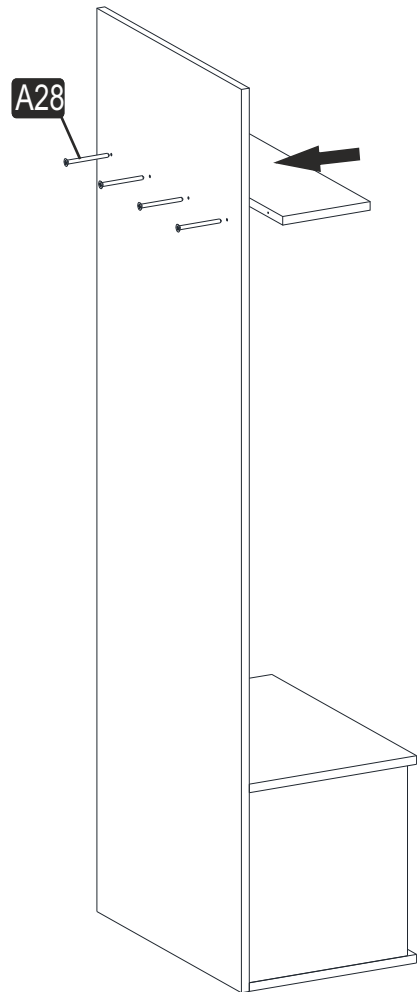
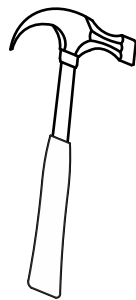
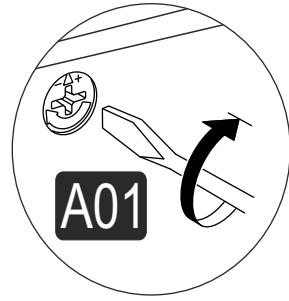
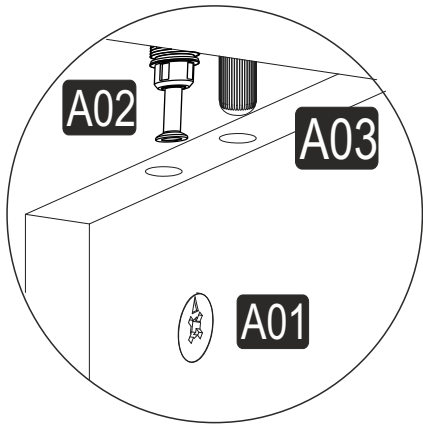
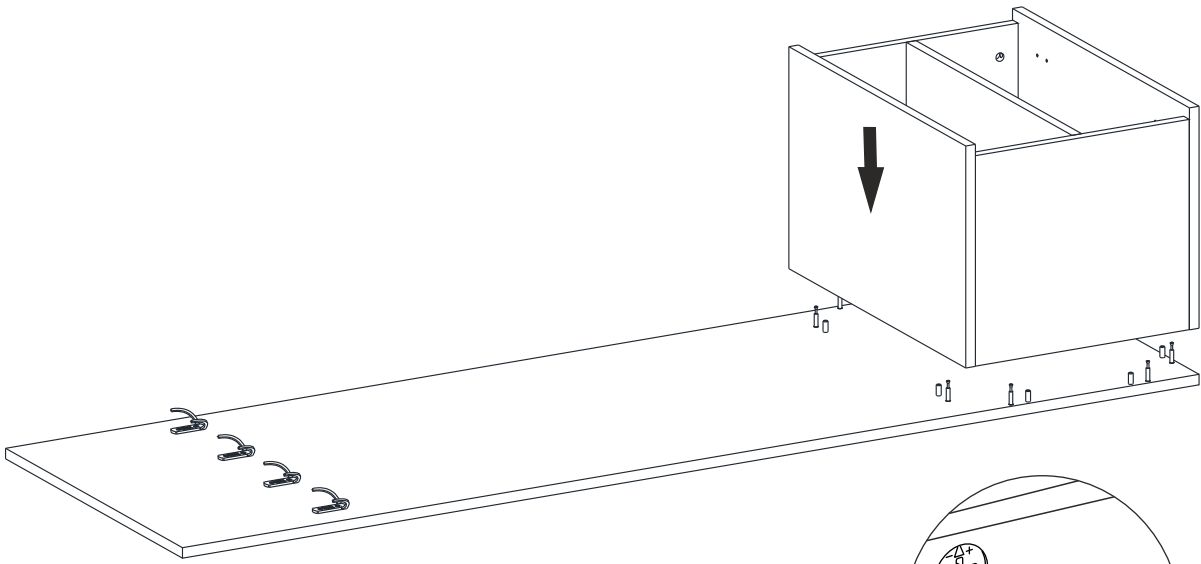

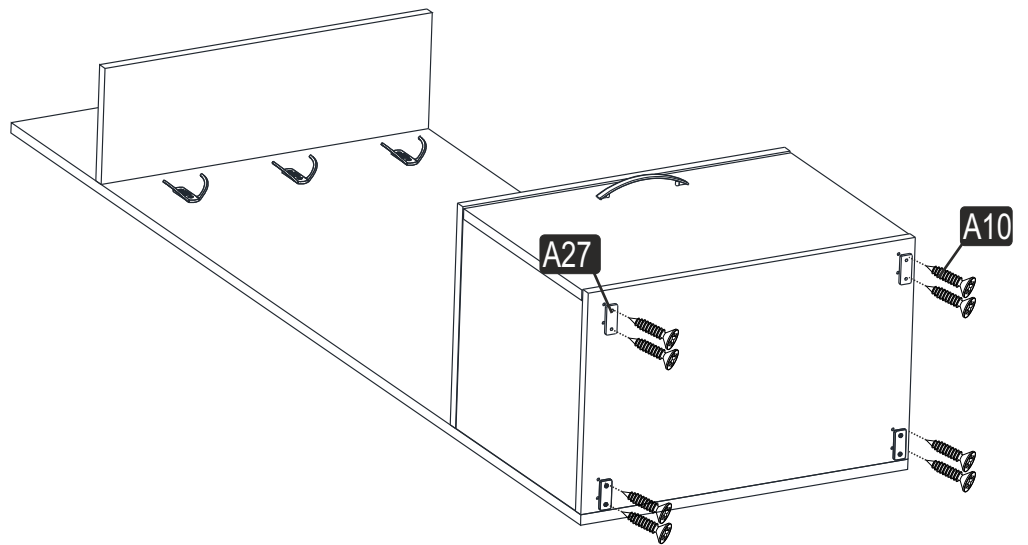
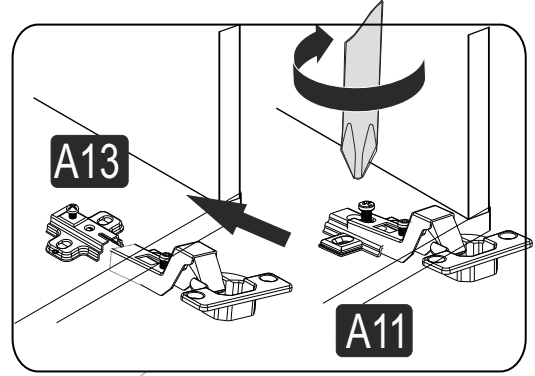
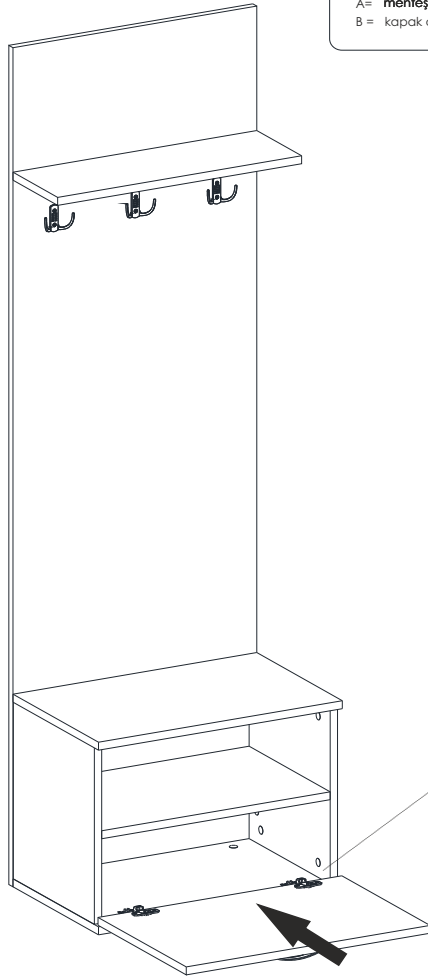
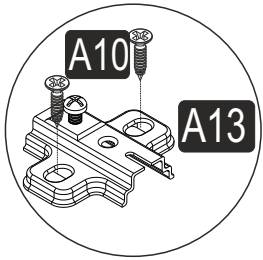
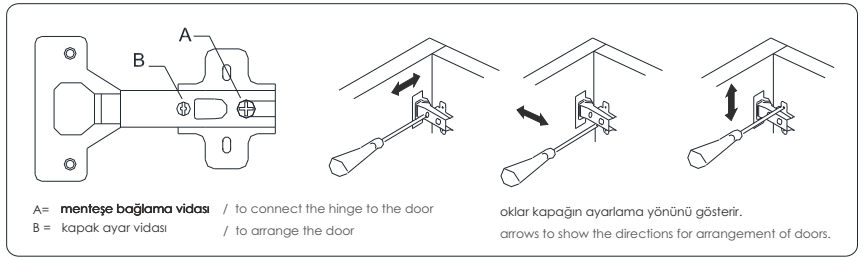

# PART-1

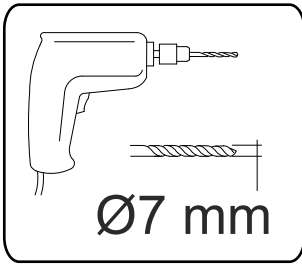

# PART-2

